

# Forward Physics at RHIC

Ramiro Debbe

BNL Physics Dept.

International Conference on  
*Strong & Electroweak Matter 2006*  
May 10-13, 2006 • Brookhaven National Laboratory

SEWM2006 10-13 May 2006



# Outline of presentation

- Kinematics of forward physics and the benefits of work in collider mode.
- BRAHMS p+p and d+Au results at high rapidity.
- Similar measurements performed by PHENIX PHOBOS and STAR.
- Future Forward physics at RHIC.

# Leading order kinematics

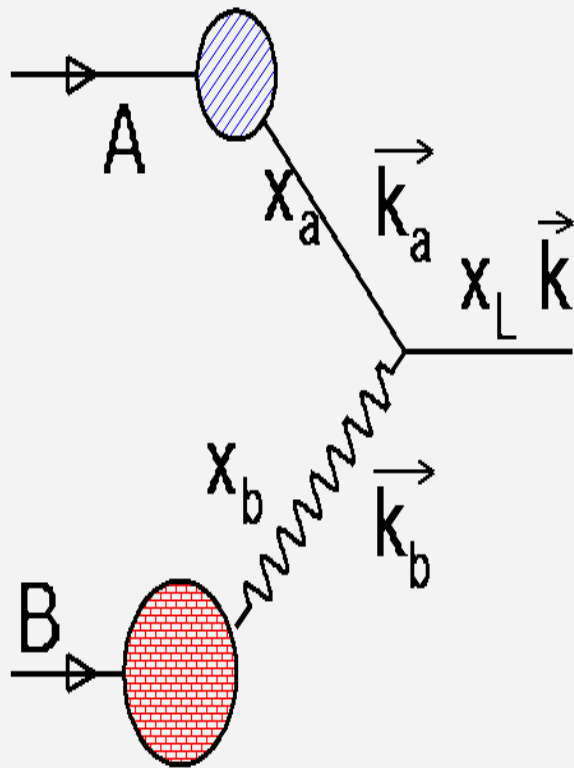

Energy and momentum conservation

$$x_L = x_a - x_b = (2M_T/\sqrt{s}) \sinh y$$

$$\vec{k}_a + \vec{k}_b = \vec{k}$$

$$x_a x_b = M_T^2/s$$

A solution to this system is:

$$x_a = (M_T/\sqrt{s}) e^y$$

$$x_b = (M_T/\sqrt{s}) e^{-y}$$

Sudakov variables

where  $y$  is the rapidity of the  $(x_L, \vec{k})$  system

In a 2->2 interaction where both partons are measured at rapidities  $y_1$  and  $y_2$ ,

$$x_a = \frac{2M_T}{\sqrt{s}} \cosh(y^*) e^{y_{\text{system}}}$$

$$x_b = \frac{2M_T}{\sqrt{s}} \cosh(y^*) e^{-y_{\text{system}}}$$

$$Y_{\text{system}} = 1/2(y_1 + y_2)$$

$$y^* = 1/2(y_1 - y_2)$$

# Parton Distribution Functions

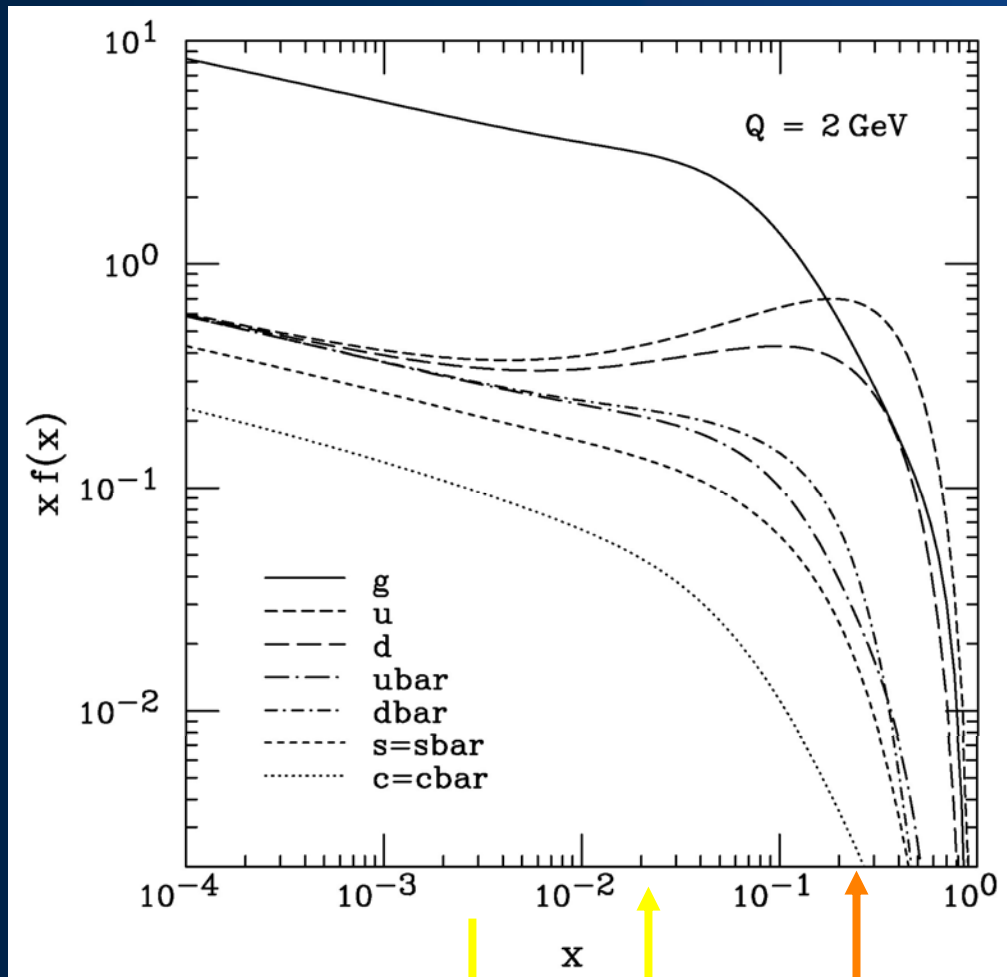

**X<sub>2</sub> range**

**X<sub>1</sub> range**

Measurements at high rapidity set the dominant parton type: **Projectile** ( $x_1 \sim 1$ ) mostly **valence** quarks.

**Target** ( $x_2 < 0.01$ ) mainly **gluons**.

# BRAHMS Experimental Setup

## Mid Rapidity Spectrometer

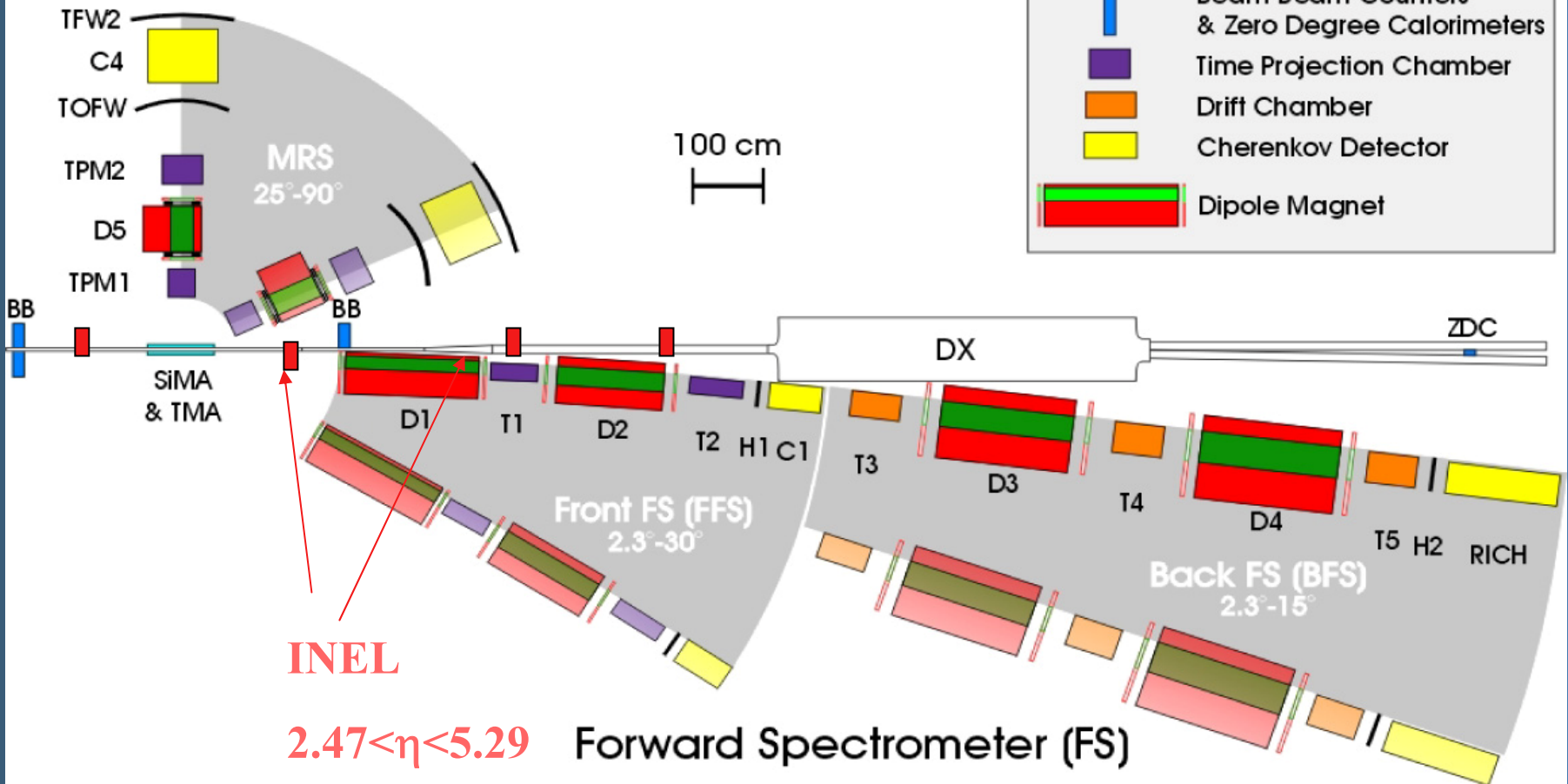

The data at forward rapidities were collected with FS at  $4^\circ$  ( $\eta \sim 3$ ) and  $2.3^\circ$  ( $\eta \sim 3.4$ )

# Particle Identification is done with **BRAHMS RICH**

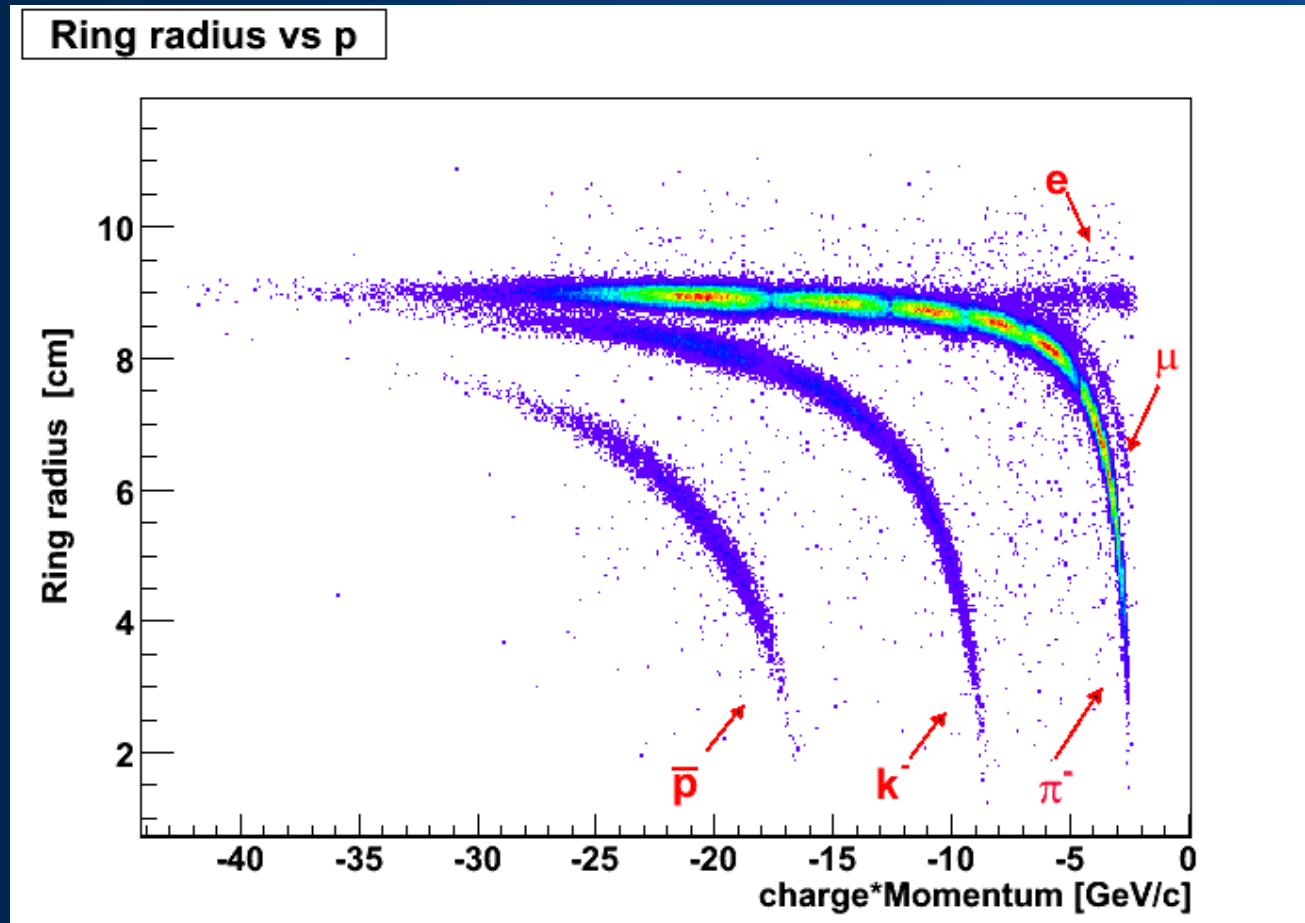



# BRAHMS d+Au results as function of rapidity and centrality

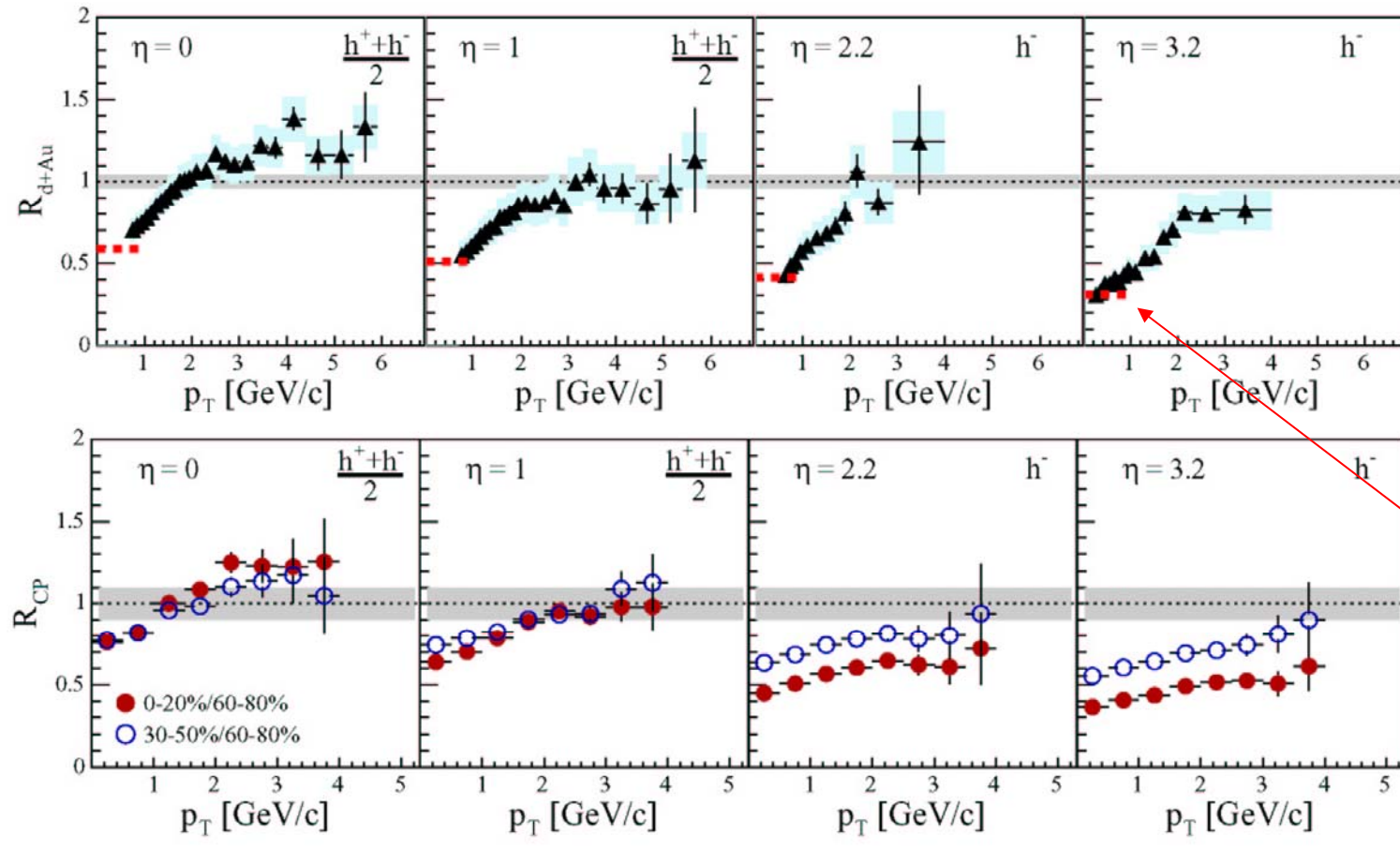

$$R_{dAu} = \frac{Y_{dAu}}{N_{coll} Y_{pp}}$$

Calculated  
from spectra

Normalized  
ratio of  
previously  
measured  
 $dN/d\eta$

$R_{cp}$  ratios are  
constructed in wide  $\eta$   
bins and with data  
from same run period

BRAHMS, PRL 93, 242303

## **BRAHMS results in the context of CGC**

**These results came just after the effects of the onset of the Color Glass Condensate at RHIC energies were predicted and a qualitative description of its effects in high rapidity particle production was offered.**

**Similar saturation effect have already been seen at HERA and the multiplicity densities in A+A at RHIC show coherence that hint to the onset of saturation. The rapidity and centrality dependence of the BRAHMS results is then the result of “quantum evolution” of an already saturated Au wave function.**



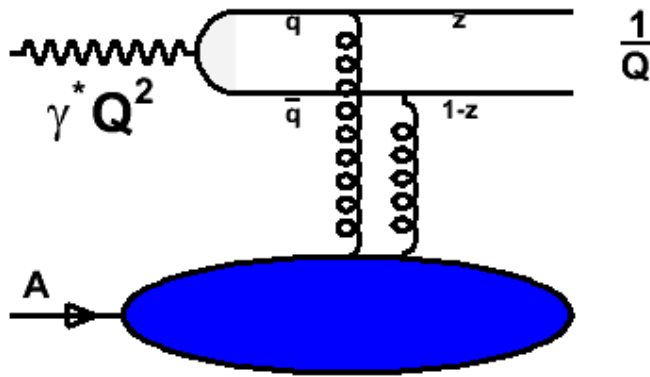

Transverse size of the color dipole is set equal to  $1/Q$  where  $Q^2$  is the virtuality of the exchanged photon.

**“Geometric Scaling”** at HERA (A. Staśto, K. Golec-Biernat et al. PRL 86 2001)

$R_0$  “saturation radius”  $\sim x^\lambda$

defines a scale: for values of  $Q^2$  such that for  $1/Q \geq R_0$

the cross section becomes a constant.

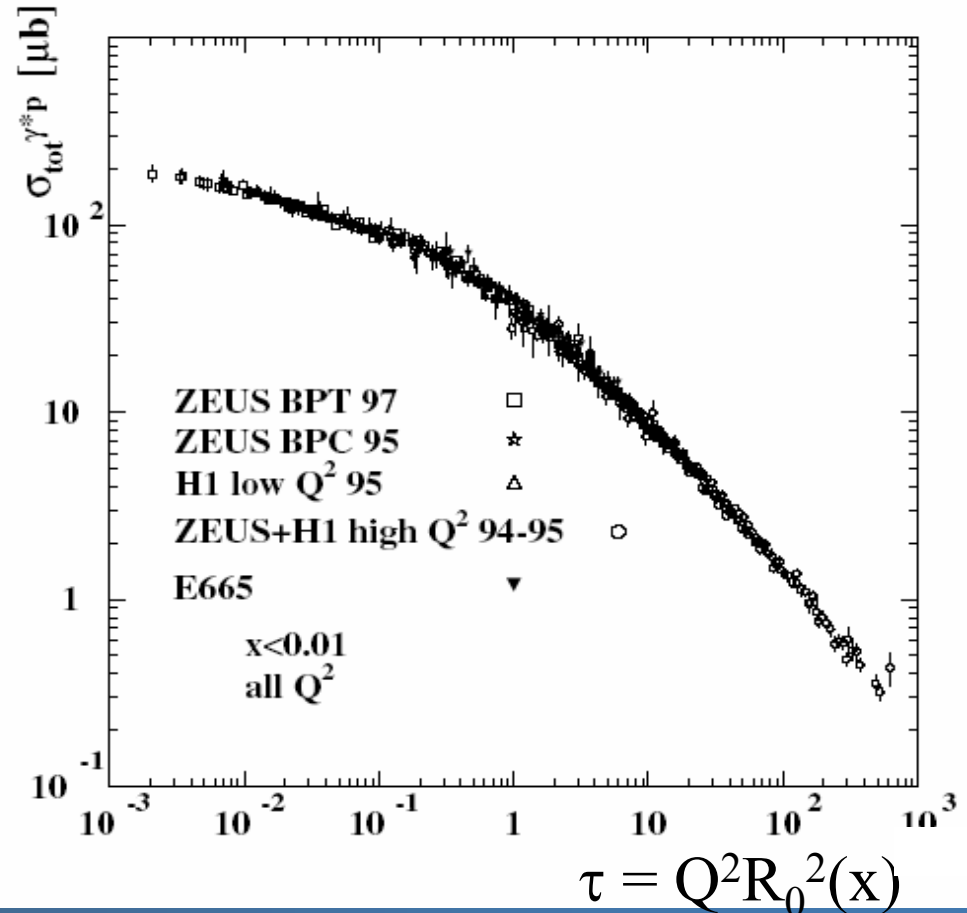

# Quantum Evolution

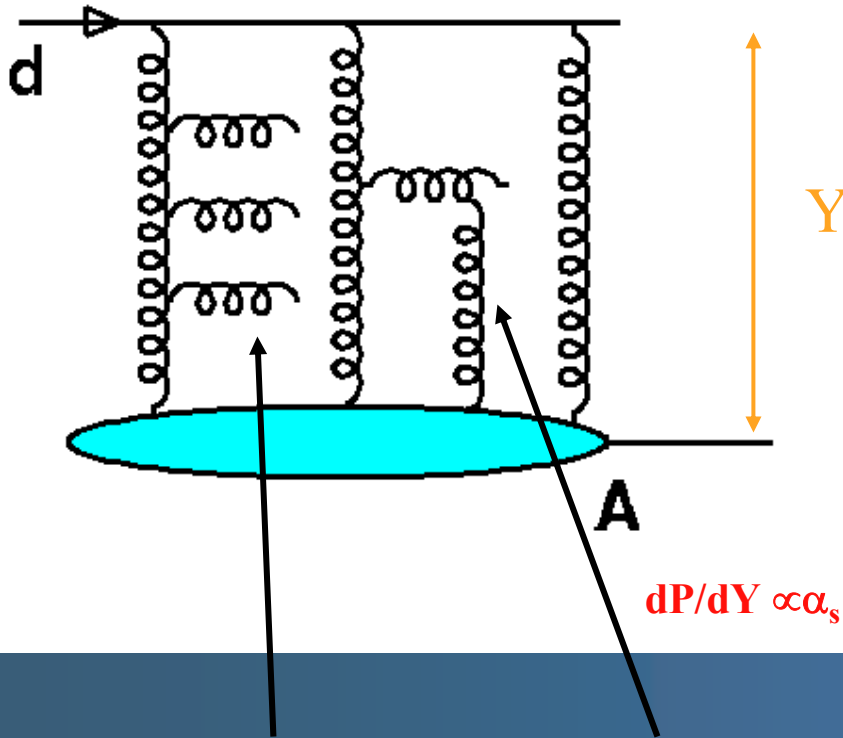

$$R_{dA} = (d\sigma^{PA}/d^2kdy)/(Ad\sigma^{PP}/d^2kdy)$$

For  $k \gg Q_s$  :

$R_{dA} < 1$  increasing with  $k$  approaching 1 from below.

For  $Q_s < k < k_{geom}$  :

$$R_{dA} \sim e^{-1.65\alpha y} \ll 1$$

For  $k \sim Q_s$  :

$$R_{dA} \sim \exp(4\alpha y(1 - \sqrt{1 + \ln A^{1/6}/2\alpha y})) < 1$$

At high energy/ rapidity it becomes constant  $R_{dA} \sim A^{-1/6}$

gluon radiation

gluon fusion

**Suppression at all  $k$ , suppression even stronger for higher  $A$**

$$dN/d(\ln 1/x) = \alpha_s (2N - N^2)$$

Kharzeev, Kovchegov and Tuchin  
Phys. Rev. D 68, 094013

# Shadowing or formation of a CGC

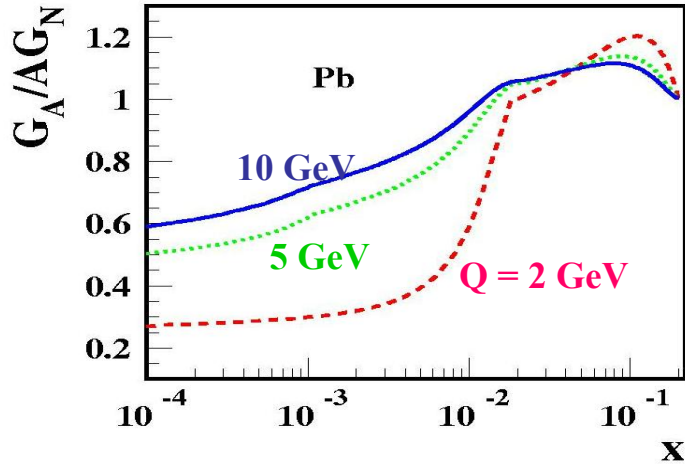

Leading twist gluon shadowing, e.g.:

- Gerland, Frankfurt, Strikman, Stocker & Greiner (hep-ph/9812322)
- phenomenological fit to DIS & DY data, Eskola, Kolhinen, Vogt hep-ph/0104124
- and many others

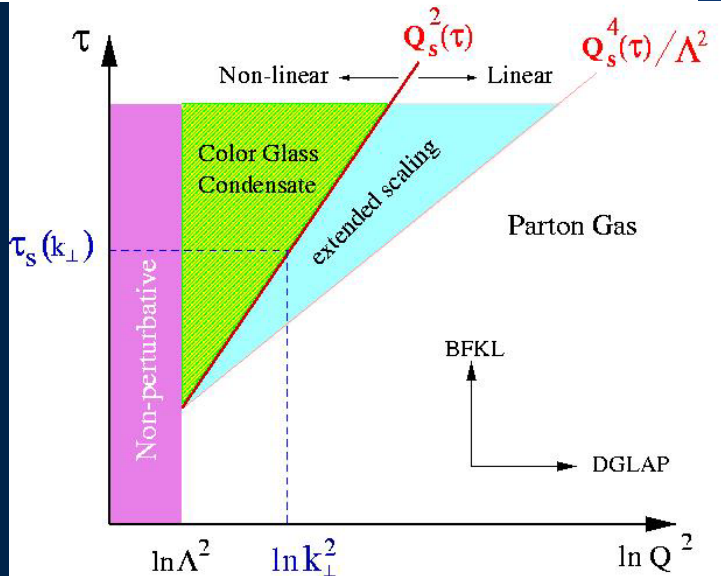

Iancu and Venugopalan hep-ph/0303204

**Amount of gluon shadowing differs by up to a factor of three between different models**

# Parameterization of nuclear shadowing in (LO) calculation

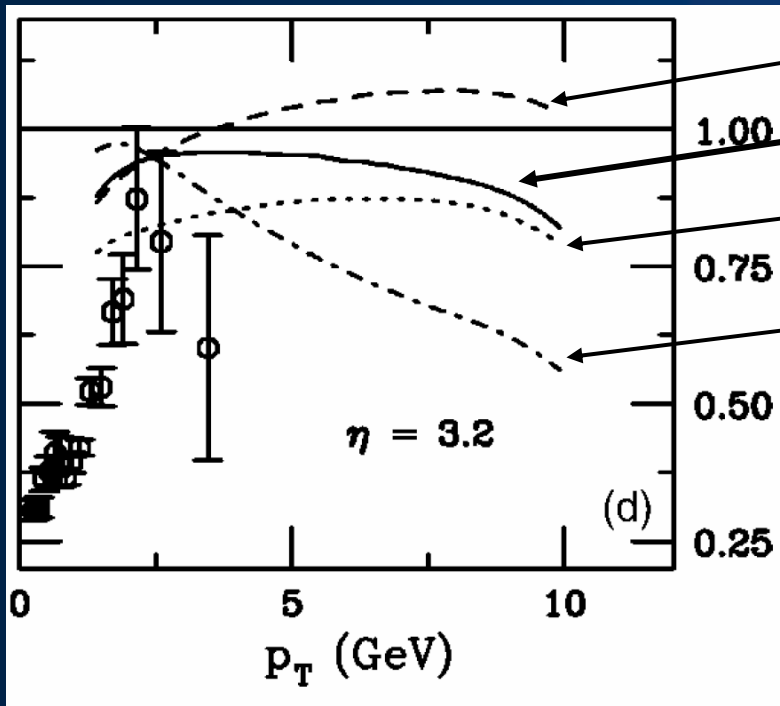

EKS98 shadowing

FGS1 parameterization  
gives similar results

R. Vogt Phys. Rev. C70 064902 (2004)

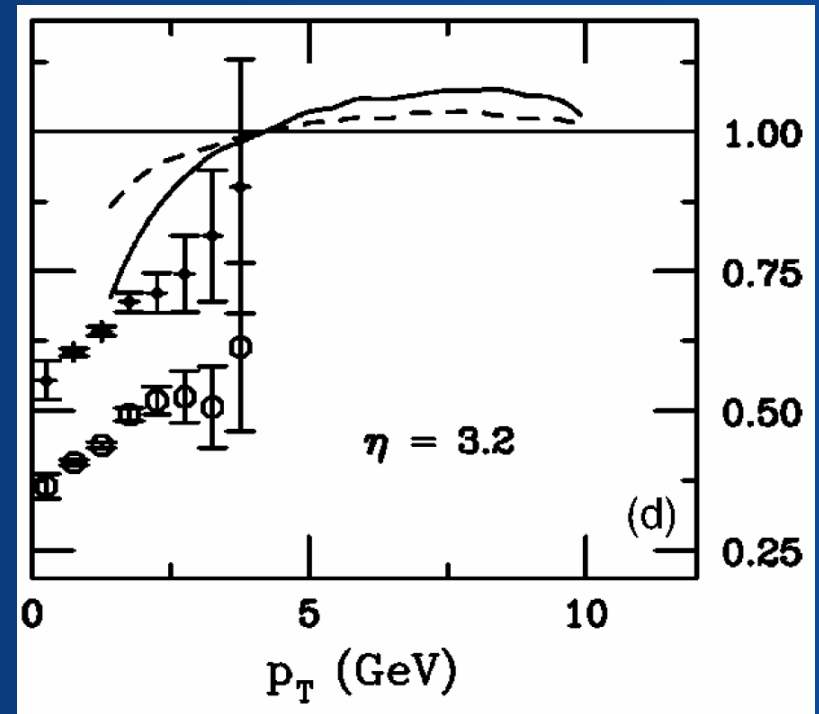

Use the spatial dependence of shadowing. FGS1 parameterization

Reasonable agreement for  $R_{dAu}$  but cannot describe the centrality dependence

# Recombination

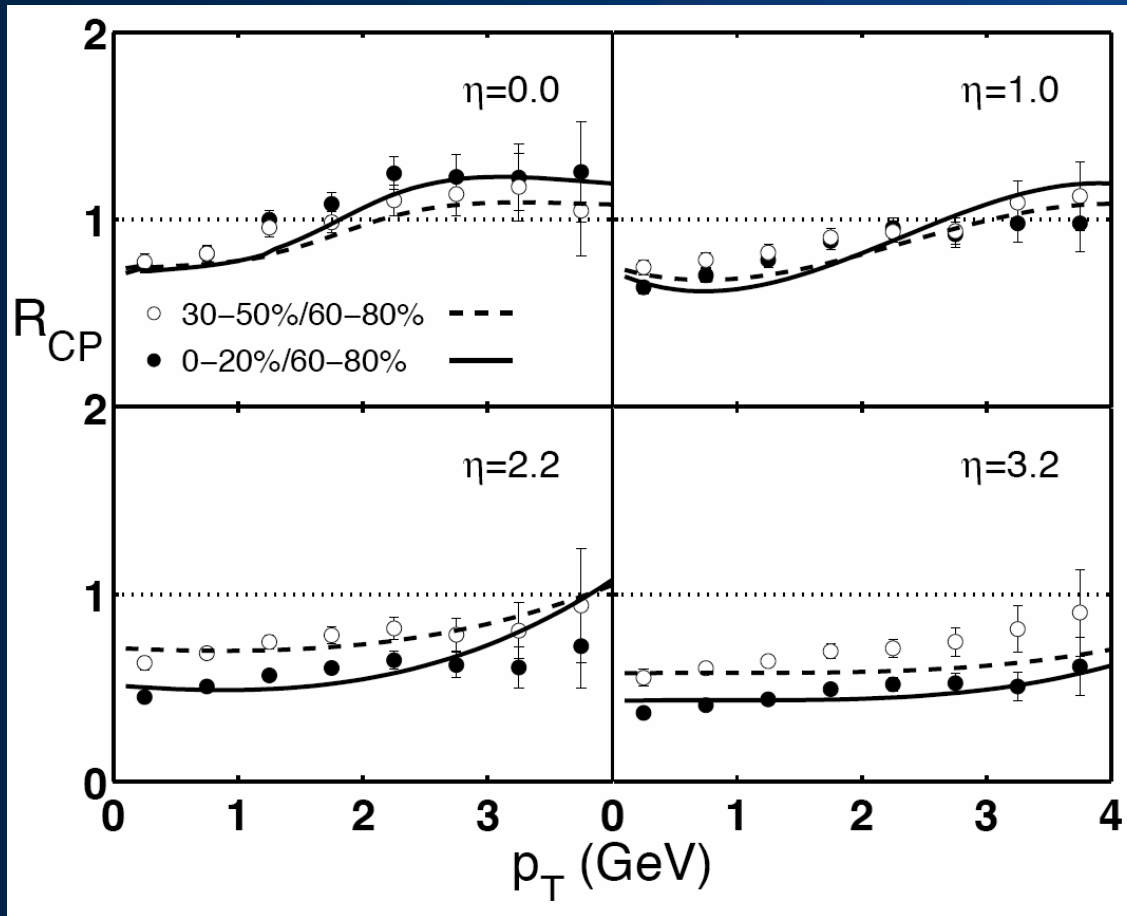

Hadronization by recombination of **soft** and **shower** partons

The decrease in  $R_{CP}$  as  $\eta$  increases is related to the drop of **dn/d $\eta$**  through the **soft** partons.

R. Hwa *et al.* Phys. Rev **C71** 024902 (2005)

# Forward hadron production and the Color Glass Condensate

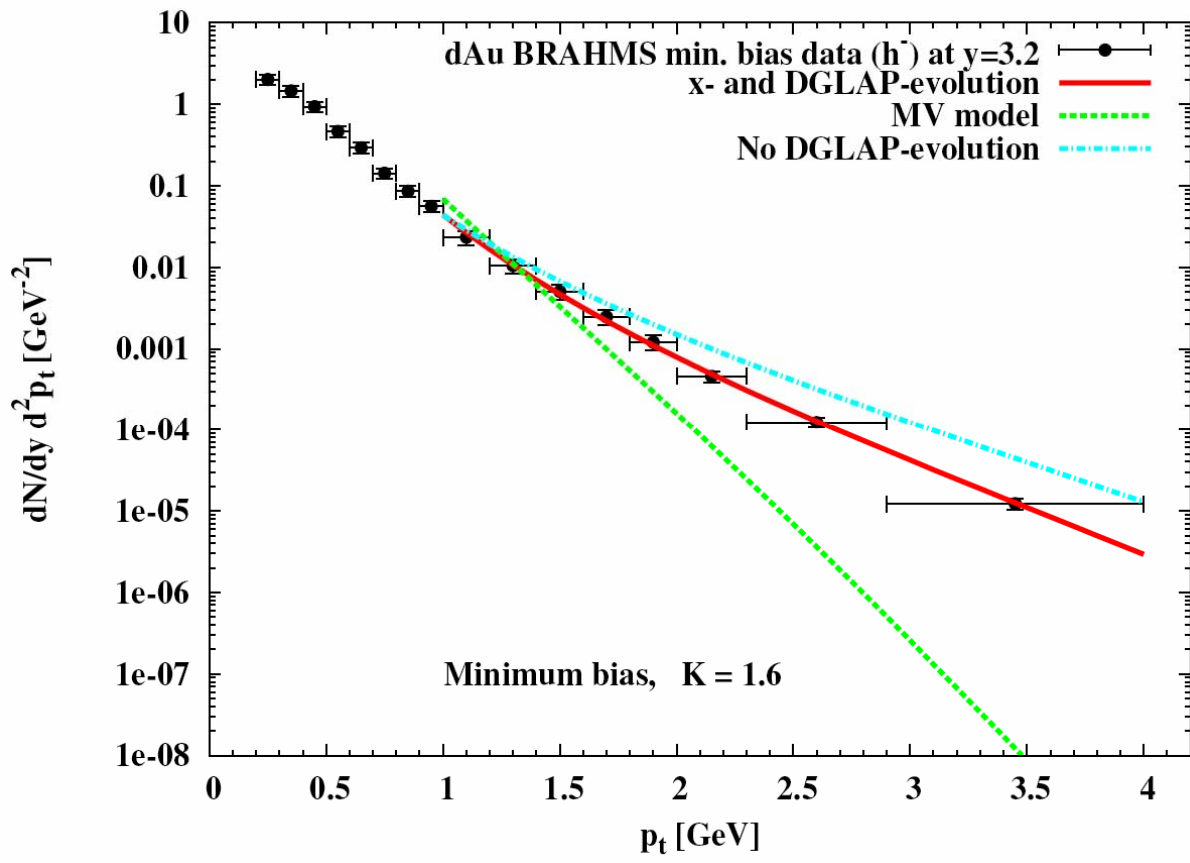

CTEQ-LO + CGC + KKP-LO[( $h^+$ + $h^-$ )/2]

**Nucl.Phys.A765:464-482,2006**

**Projectile: collection of quarks and gluons subject to DGLAP evolution.**

**Target: CGC subject to quantum evolution.**



# p+p identified spectra at high rapidity

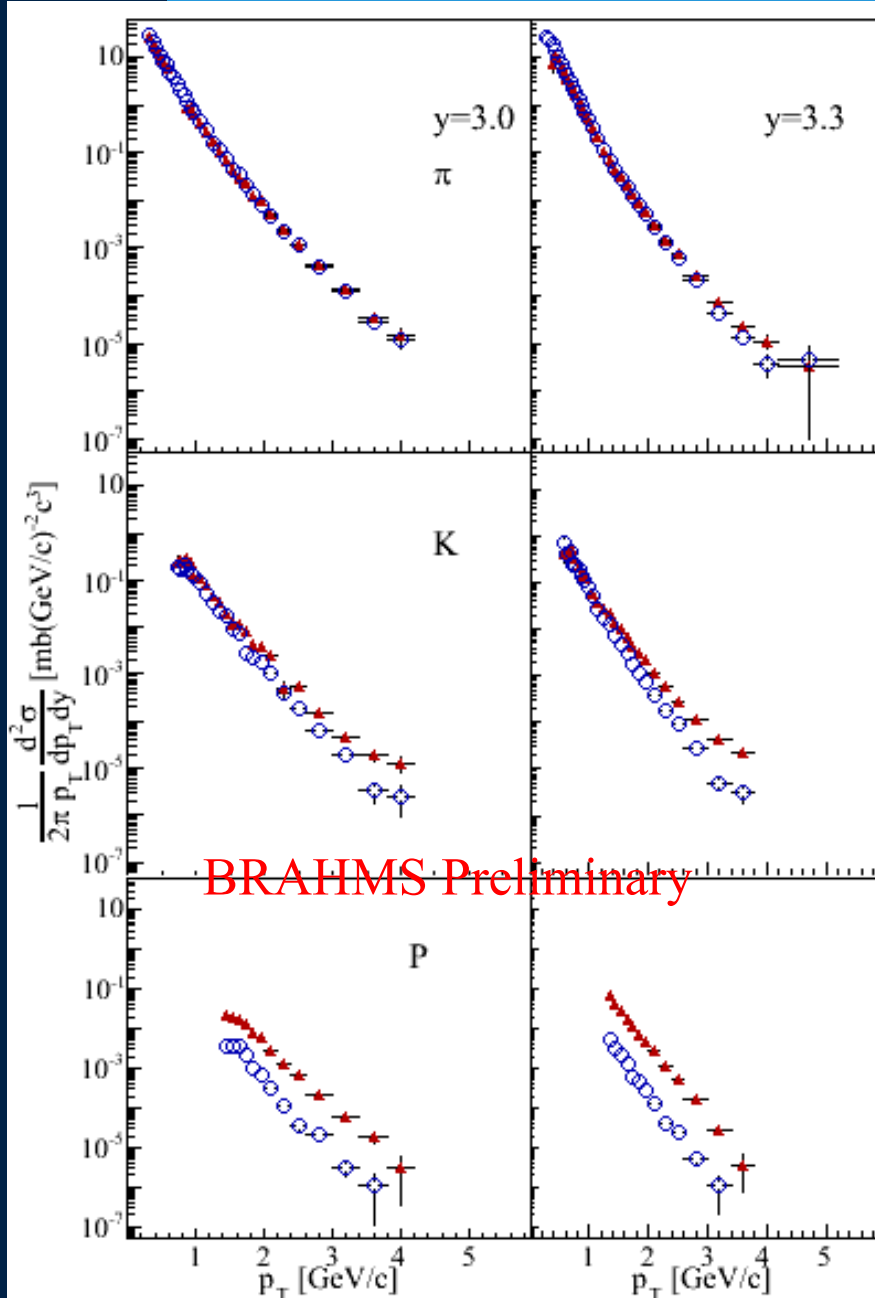

**Red** : positive

**Blue empty**: negative

Built with data from 4 and 2.3 degrees and up to six magnetic field settings.

Geometrical acceptance corrections applied as well as absorption and decay in flight.

Trigger bias ( $\sim 20\%$ ) is also corrected. **Normalization to total inelastic cross-section (40 mb)**

# Ratios $p/\pi^+$ at $y=3.0$ and $3.3$

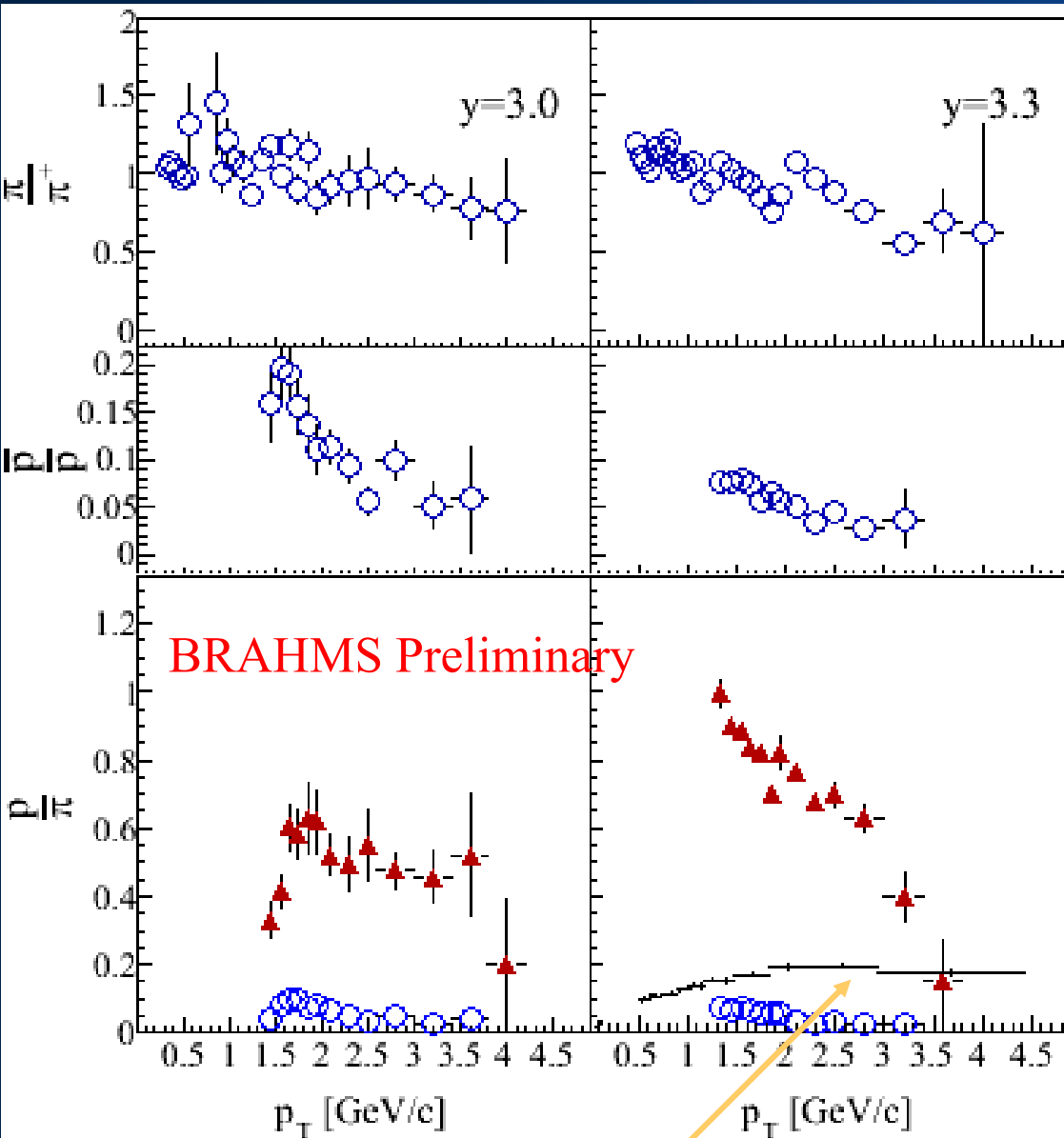

The  $\pi^+/\pi^-$  ratio is consistent with dominance of valence quarks at these rapidities.

Small  $p\bar{p}$  ratio eliminates gluon fragmentation into  $p/p\bar{p}$

The difference between protons and anti-protons indicates another mechanism besides fragmentation that puts so many protons at high  $p_T$  at this rapidities.

# Comparison of measurement and NLO pQCD calculations

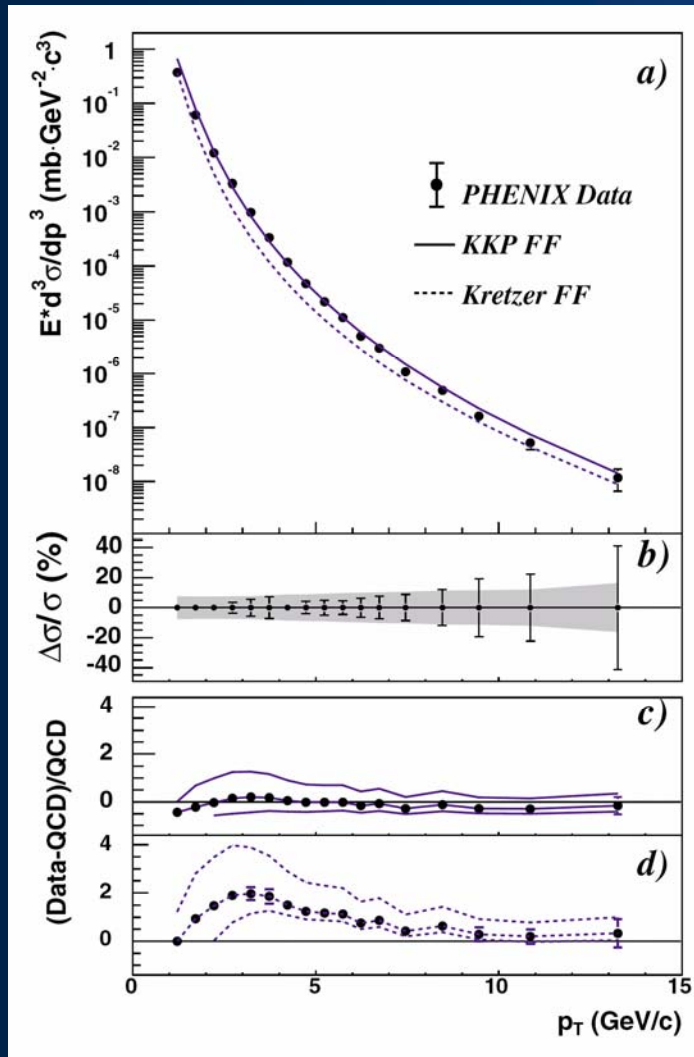

NLO pQCD can reproduce the data at RHIC energies. This is a strong indication that correct description of these

The frag. functions differ by the amount of  $g \rightarrow \pi$ . The data points toward a dominance of gluon-gluon and gluon-quark below 10 GeV/c

# NLO-pQCD can reproduce $y \sim 0$ hadron production at ISR but fails at higher rapidities.

$\sqrt{s}=23.3\text{GeV}$

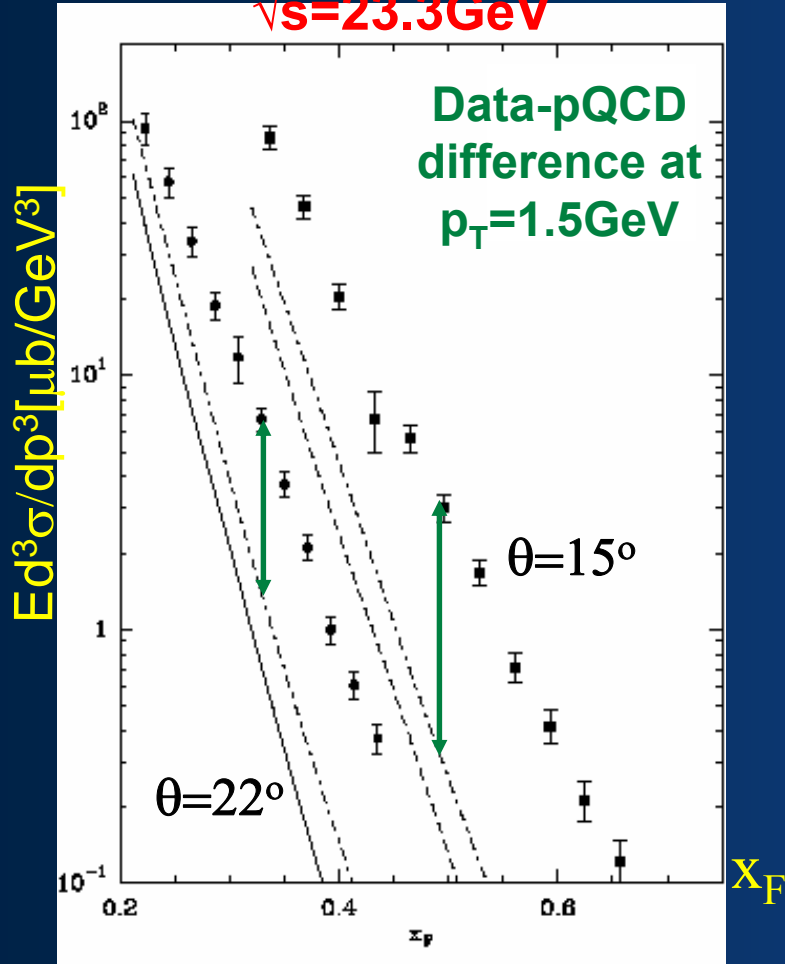

$\sqrt{s}=52.8\text{GeV}$

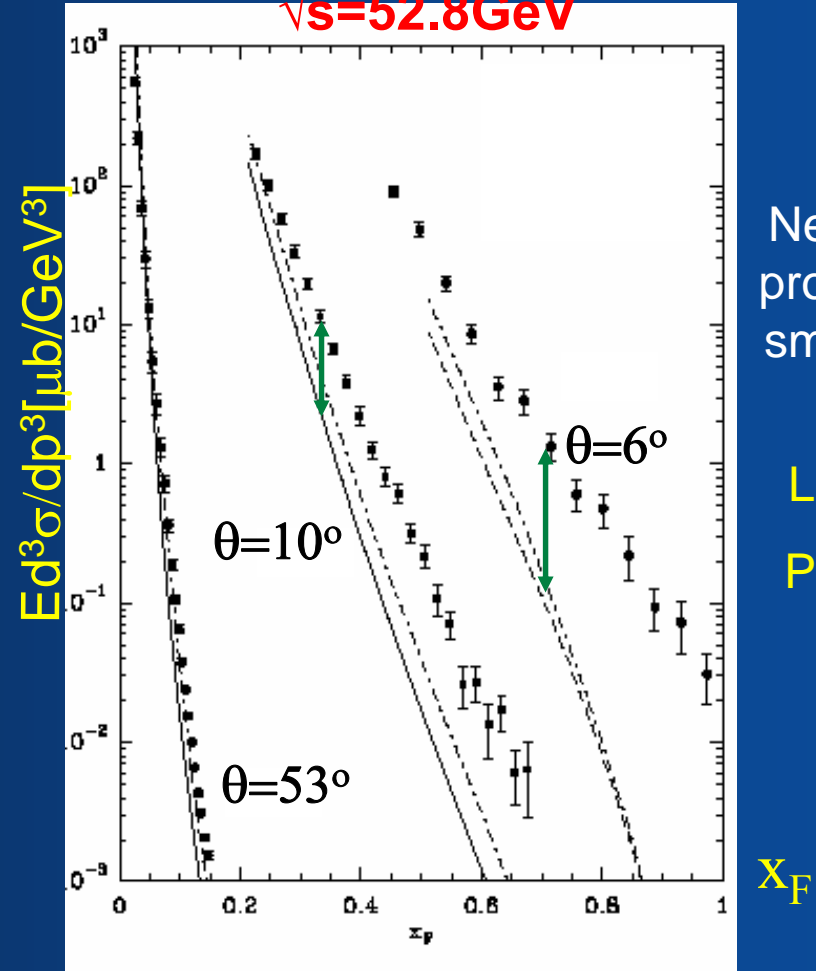

Neutral pion production at small angles at ISR

Lloyd et al.

PRL 45 89 (1980)

Bourrely and Soffer Eur. Phys. J. C36 371-374 (2004)

# NLO pQCD comparisons to data

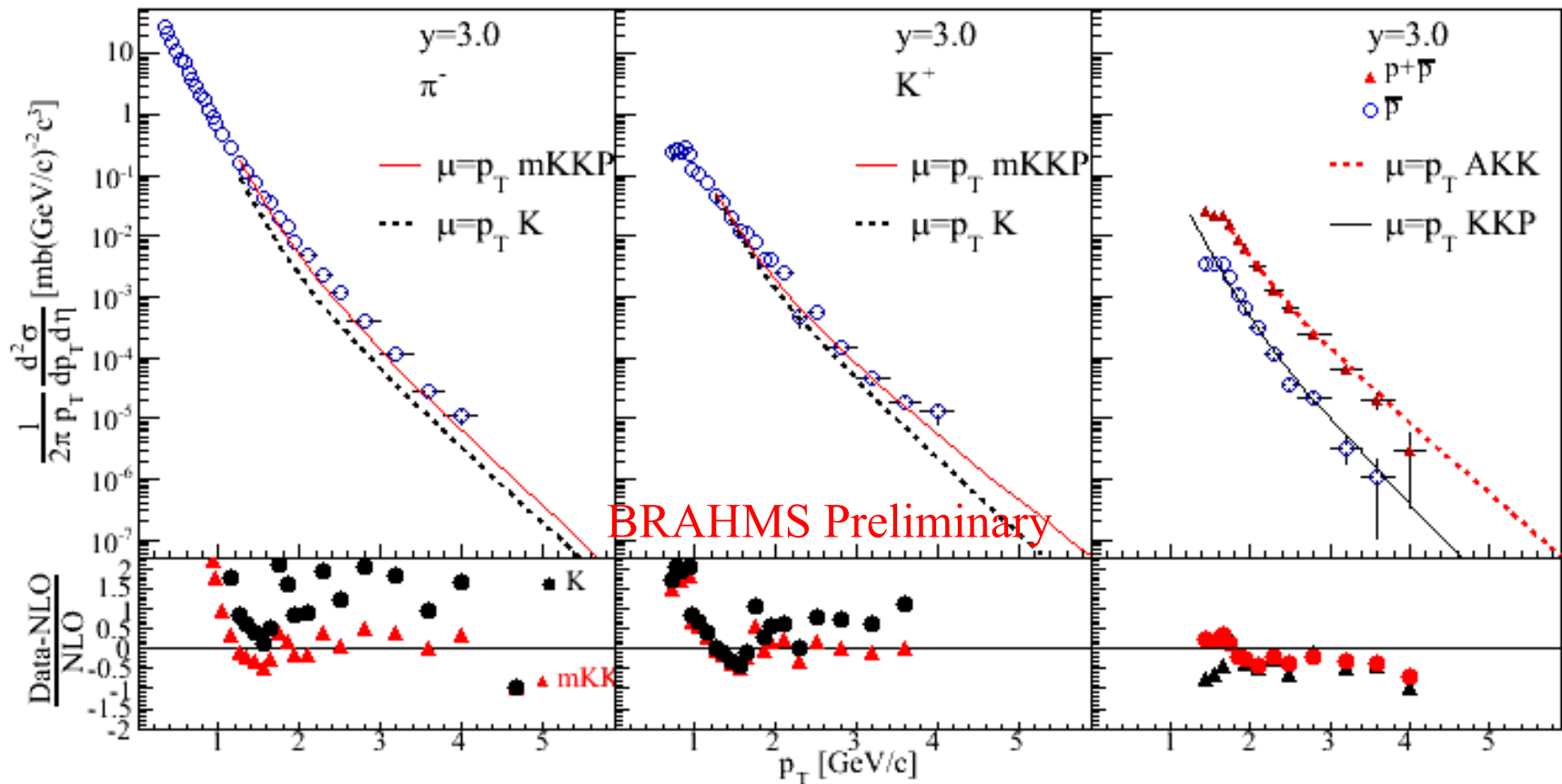

Calculations done by W. Vogelsang. Only one scale  $\mu=p_T$  and the same fragmentation functions as used for the PHENIX comparison.

KKP has only  $\pi^0$  frag. Needed some modification to produce charged pions

**The KKP does a better job compared to Kretzer, can we extend the conclusion about gg and gq dominance at these rapidities?**

# NLO pQCD for proton+anti-proton compared to data

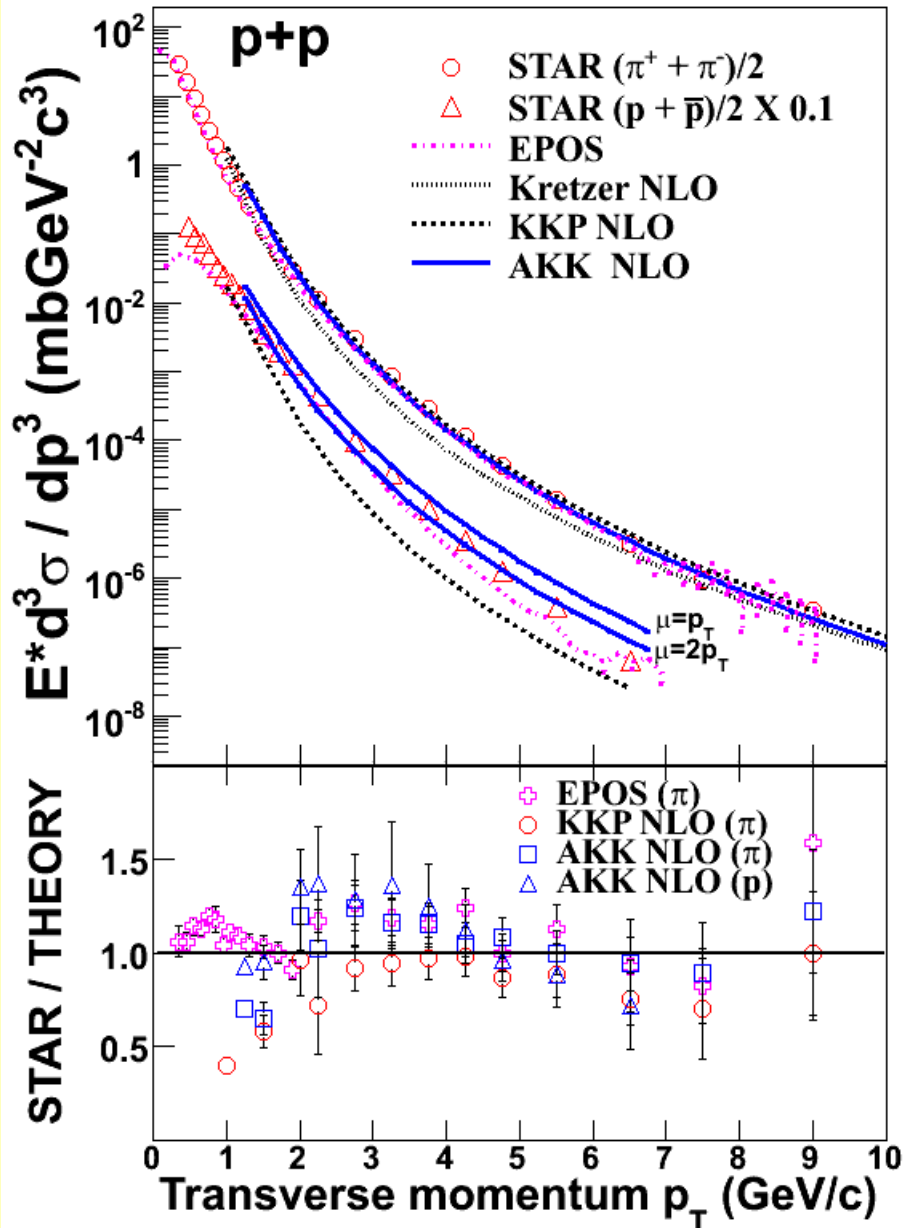

A recent update of the KKP fragmentation function is used here: AKK where  $g \rightarrow p$  has increased relevance.

The AKK function does well at  $y=0$  (STAR p+p-) where the ratio anti-p/p  $\sim 1$  can be seen as consistent with dominance of  $gg$  or  $gq$  processes, **but in my opinion is not appropriate for high rapidities.**



# d+Au re-analysis

The analysis of the d+Au data is underway, this time we include particle identification (RICH) in the full spectrometer FS

**Red** : positive

**Blue empty**: negative

**Data sample:**

**Negatives: full field + 1/4**

**Positives: full field 1/2 1/4**

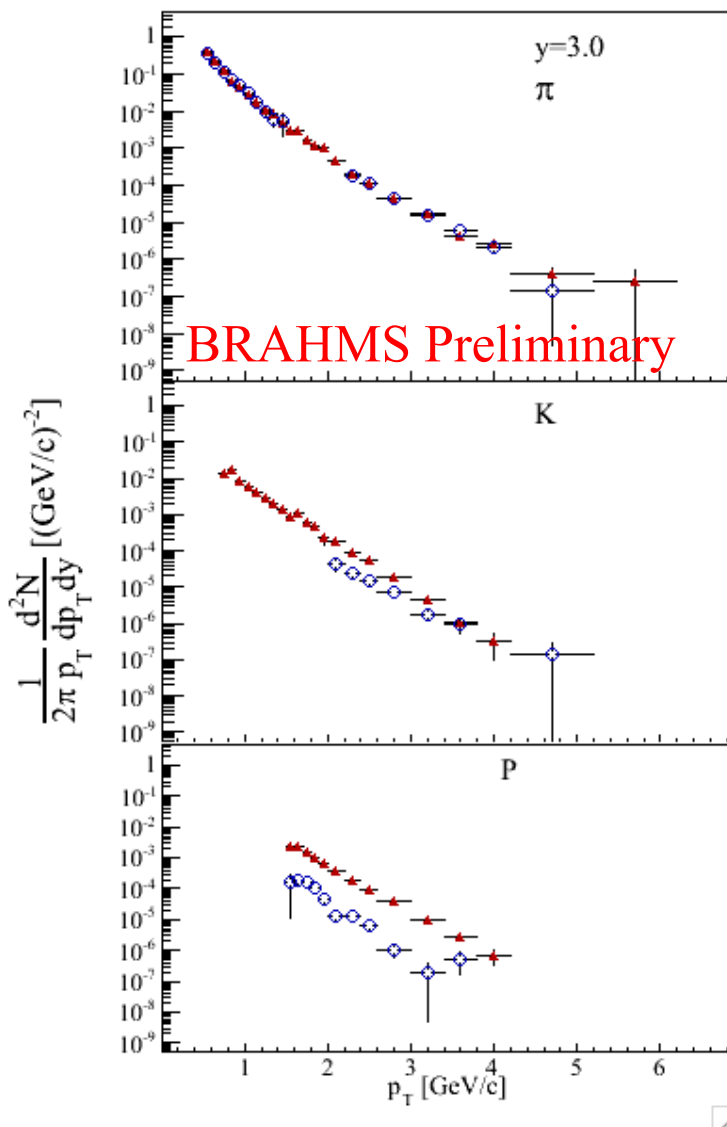

# Nuclear modification factors with pid

**Red: positive**

**Open blue: negative**

As expected there is a difference between positive and negative pions driven by a “suppression” of negative pions in p+p (isospin)

Protons are showing a hint enhancement, but a “suppression” in the anti-proton  $R_{dAu}$  remains after several checks on the analysis.

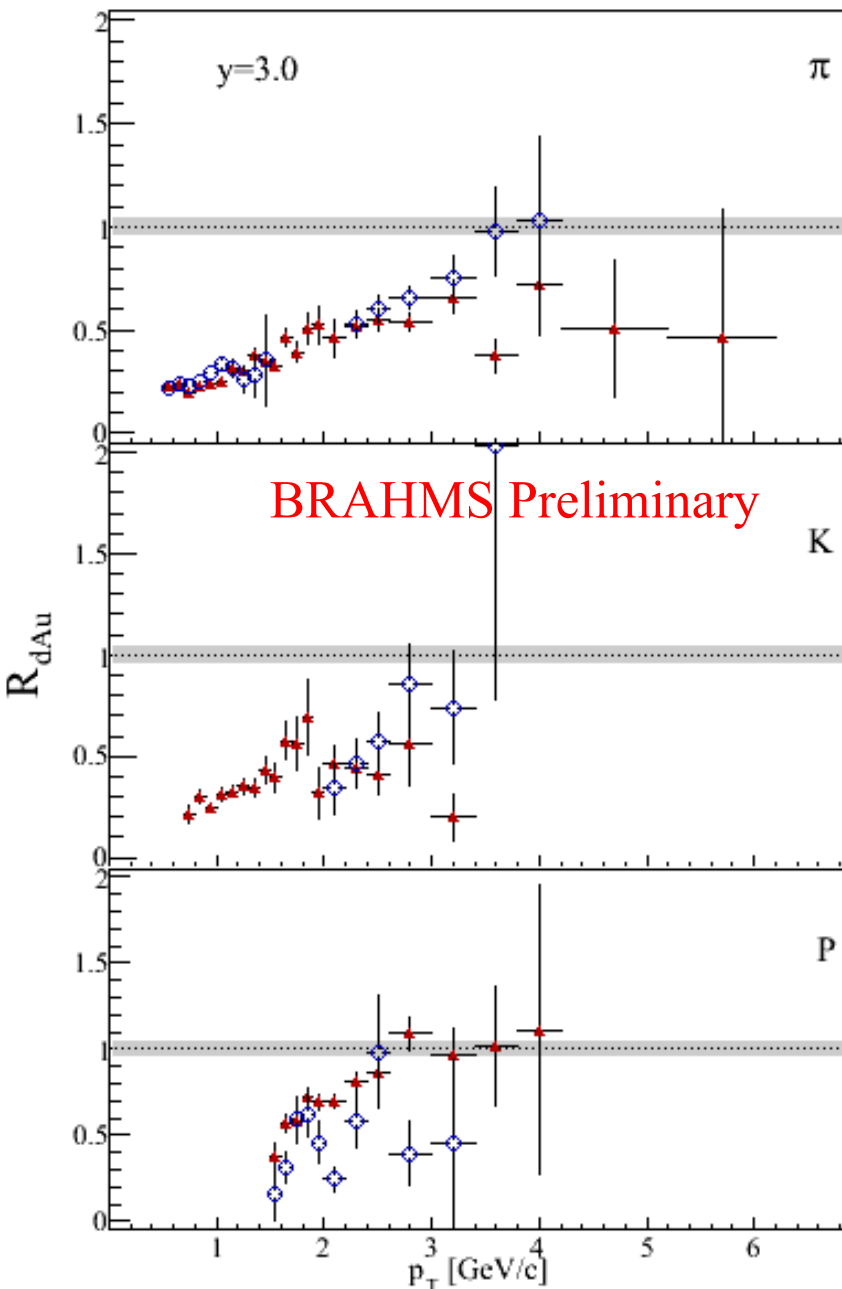

# Production of protons with high $p_T$ at high rapidity

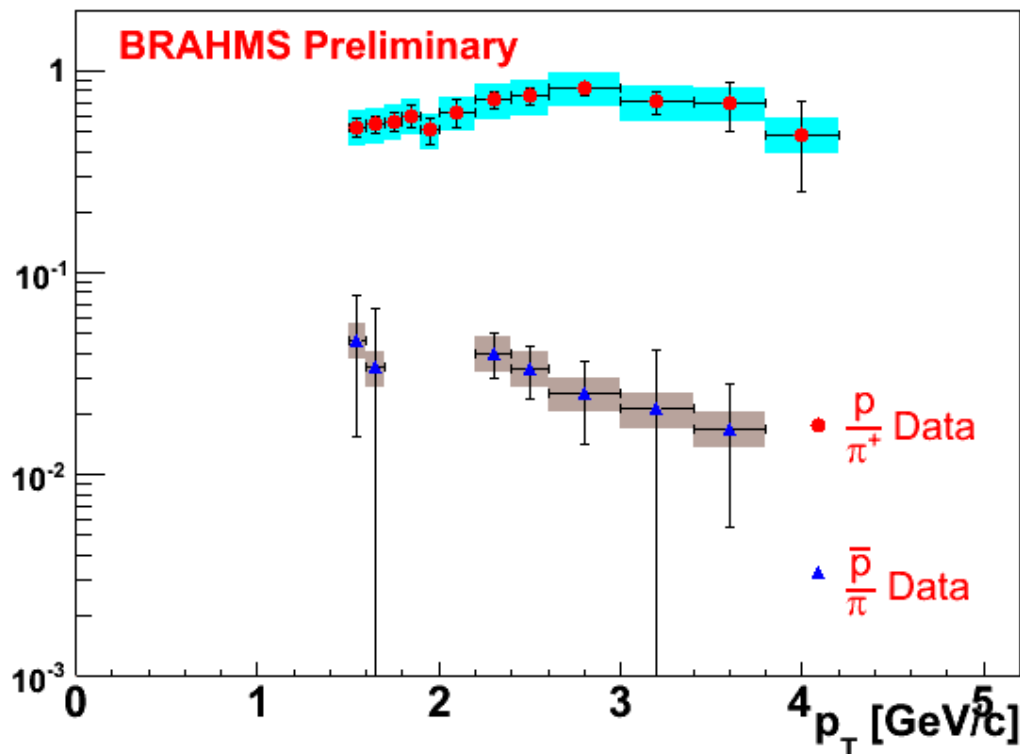

Protons can be as much as 80% of the pion yield at high  $p_T$ . This explains the difference between  $h^+$  and  $h^-$ .

$p/\pi^-$  is similar to the ratios found in  $e^+e^-$  collisions; DELPHI Euro. Phys. C17 207, (2000)

# Similar effects measured by PHENIX and PHOBOS

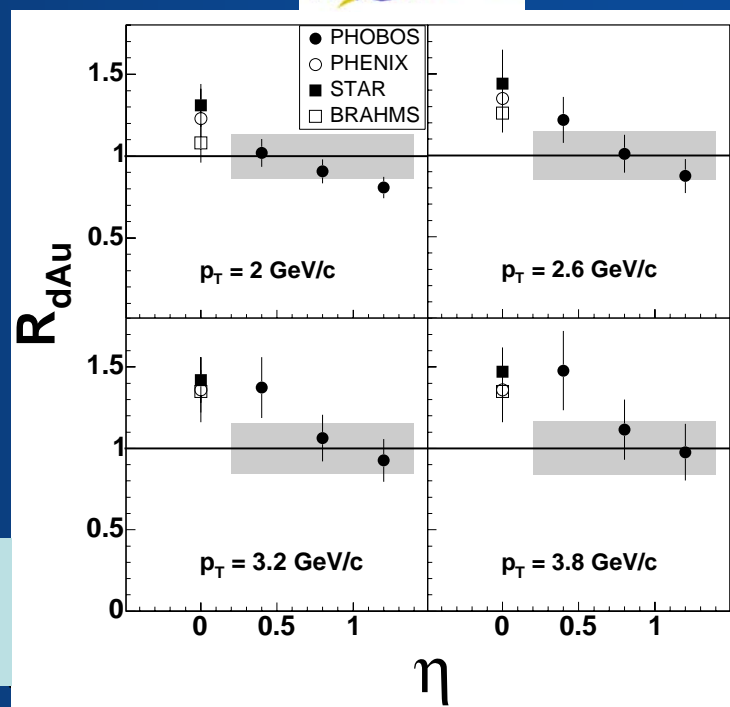
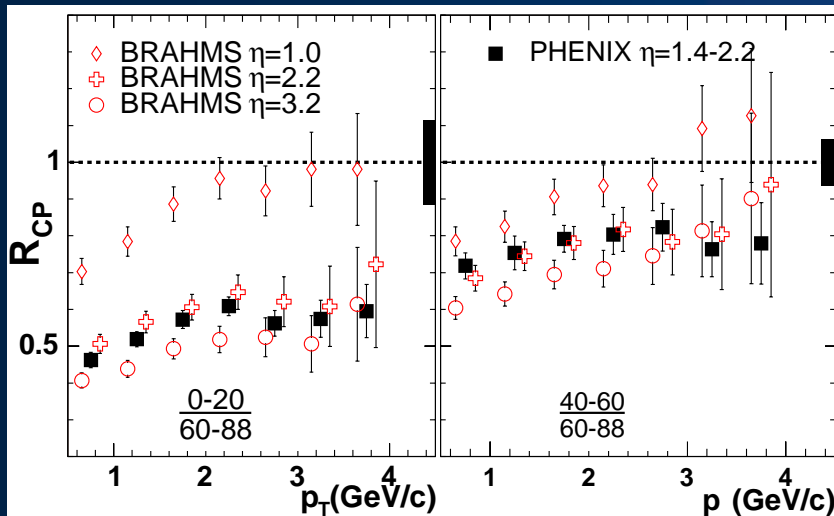
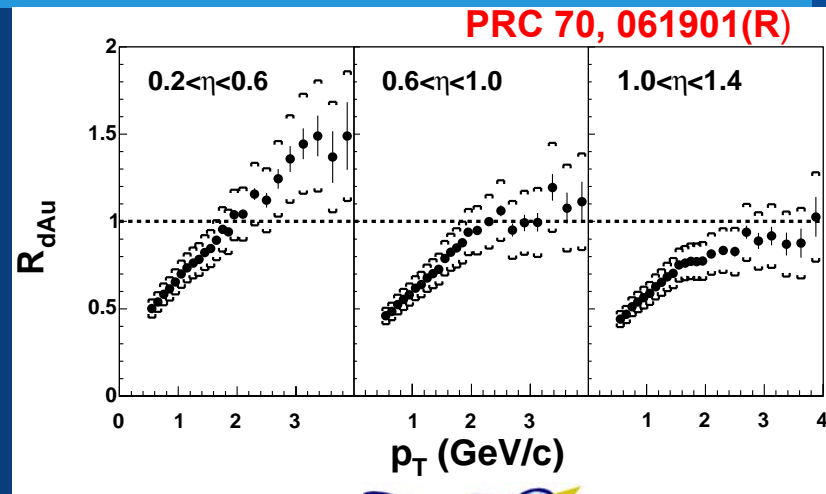
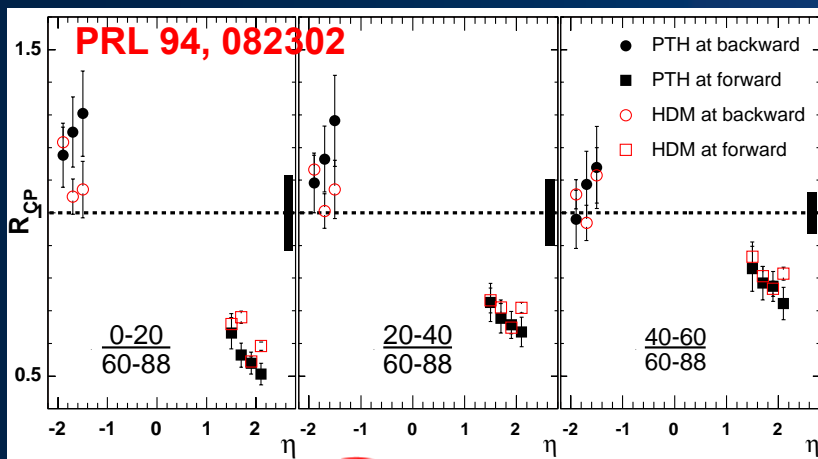

Suppression in the d direction and enhancement in the Au frag. region

# STAR $\pi^0$ at high rapidity

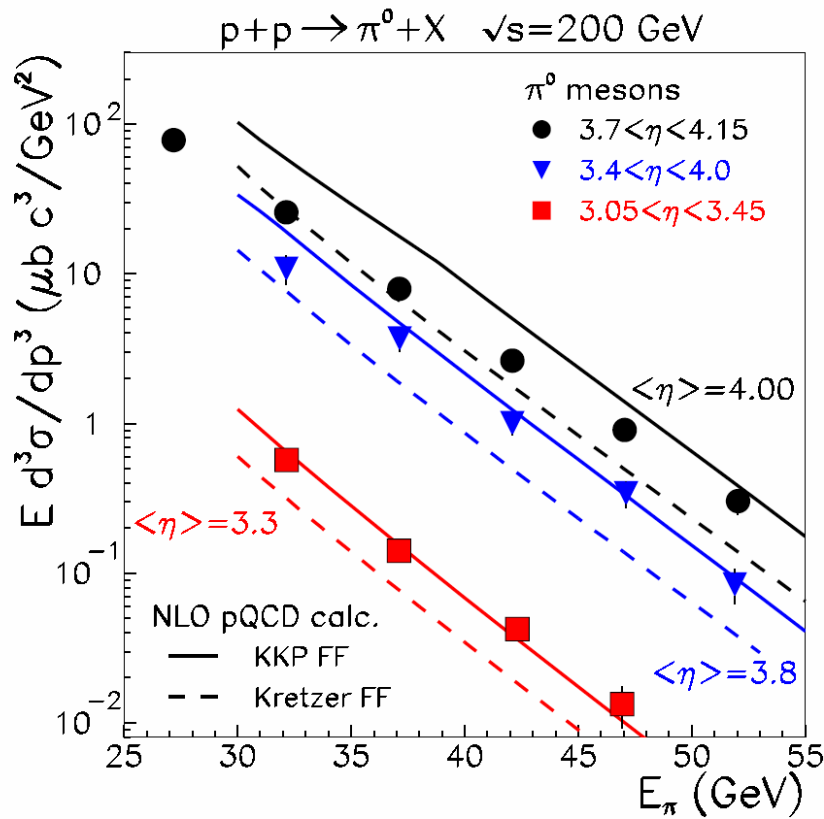

Spectra at 3.3 and 3.8 obtained with a smaller FPD

KKP frag. func. has higher  $g \rightarrow \pi$  than Kretzer

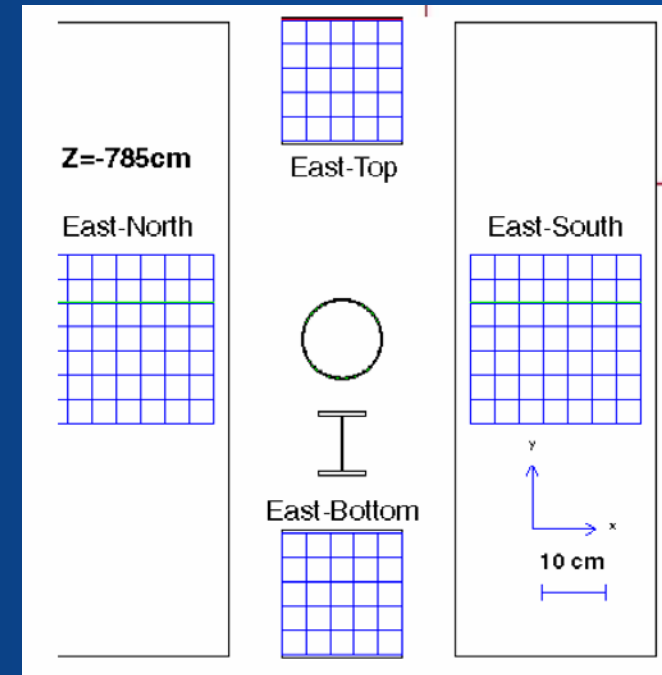

FPD: Lead-glass arrays  
 $3.4 < \eta < 4.0$  on both sides of collision.

arXiv:nucl-ex/0602011

# STAR Forward $\pi^0$ from d+Au collisions

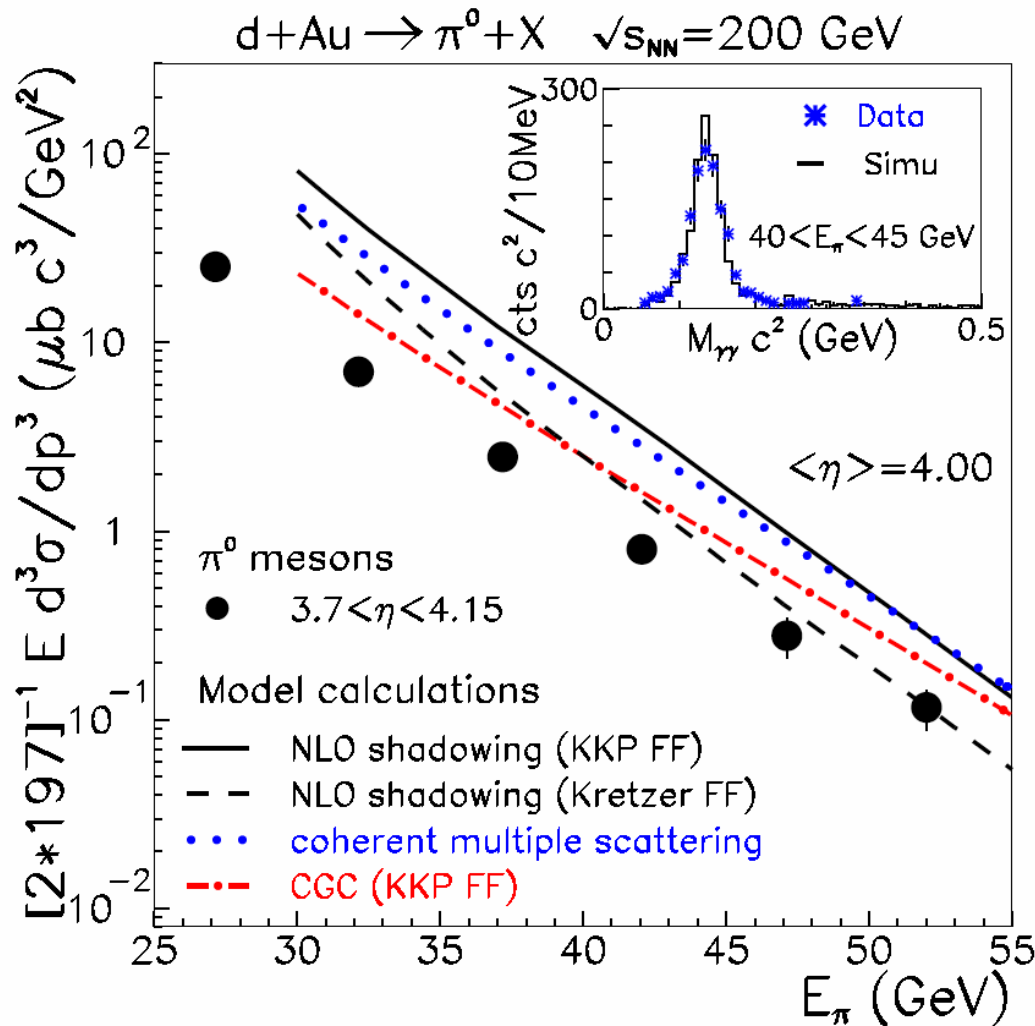

Inclusive  $\pi^0$  cross section per binary collision from d+Au at  $\langle \eta \rangle = 4$

CGC calculation is the closest to data, use of Kretzer FF will improve agreement.

CGC: A. Dumitru et al., Nucl. Phys. A765, 464 (2006)

MS: I. Vitev et al. PRL 93 262301 (2004)

NLO: W. Vogelsang



# STAR Nuclear Modification Factor at high rapidity

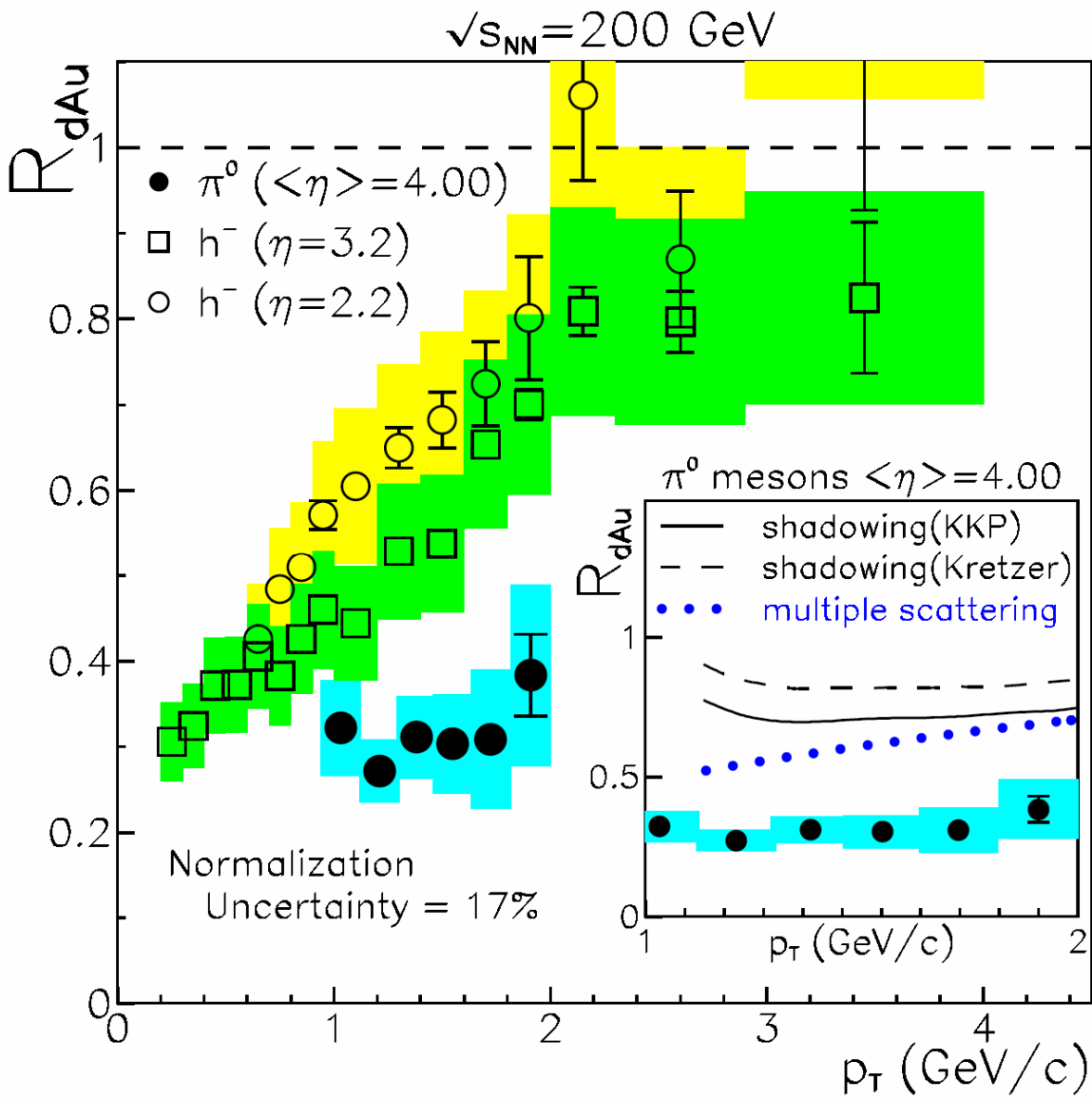

$$R_{dAu}^Y = \frac{\sigma_{inel}^{pp}}{\langle N_{bin} \rangle \sigma_{hadr}^{dAu}} \frac{E d^3\sigma/dp^3(d + Au \rightarrow Y + X)}{E d^3\sigma/dp^3(p + p \rightarrow Y + X)}$$

The new **STAR** result is consistent with published **BRAHMS** once an isospin suppression of  $h^-$  in  $p+p$  is taken into account.

Calculations that do not include mod. of Au wave function cannot reproduce data.

# Back-to-back azimuthal correlations

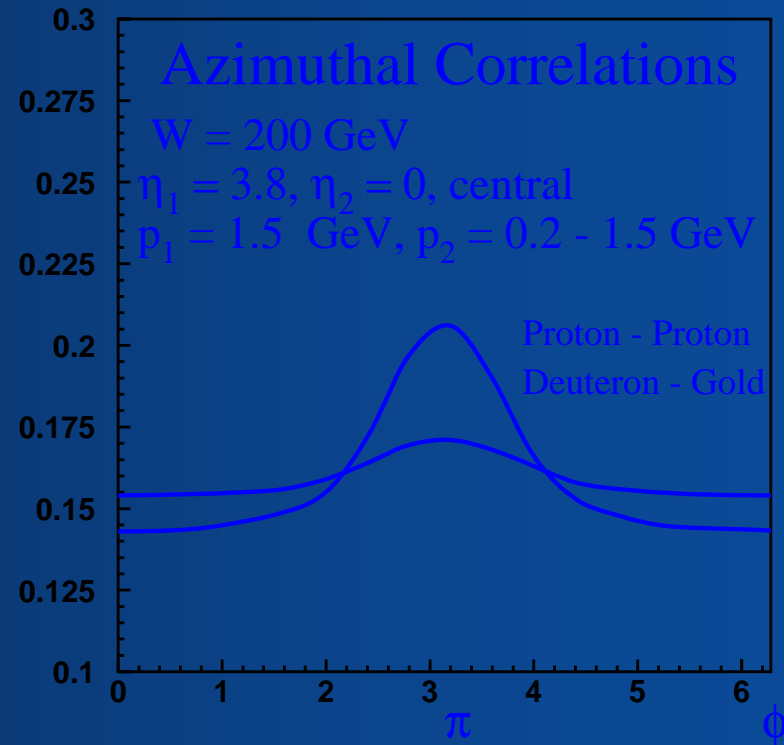
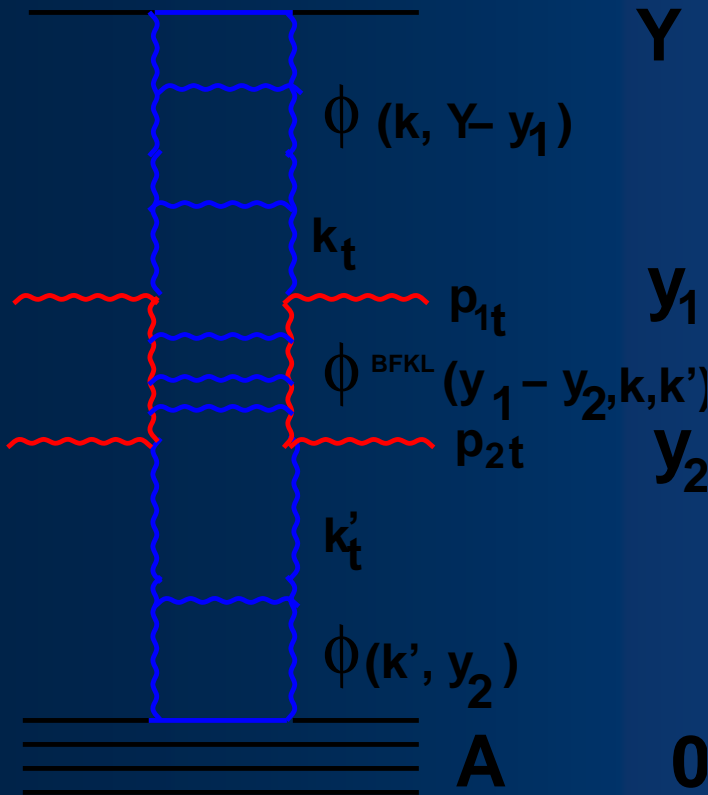

The emission of gluons ( $p_T \sim Q_s$ ) between the jets makes the correlations disappear.

(Kharzeev, Levin, and McLerran, NP A748, 627)

# Back-to-back Correlations in d+Au

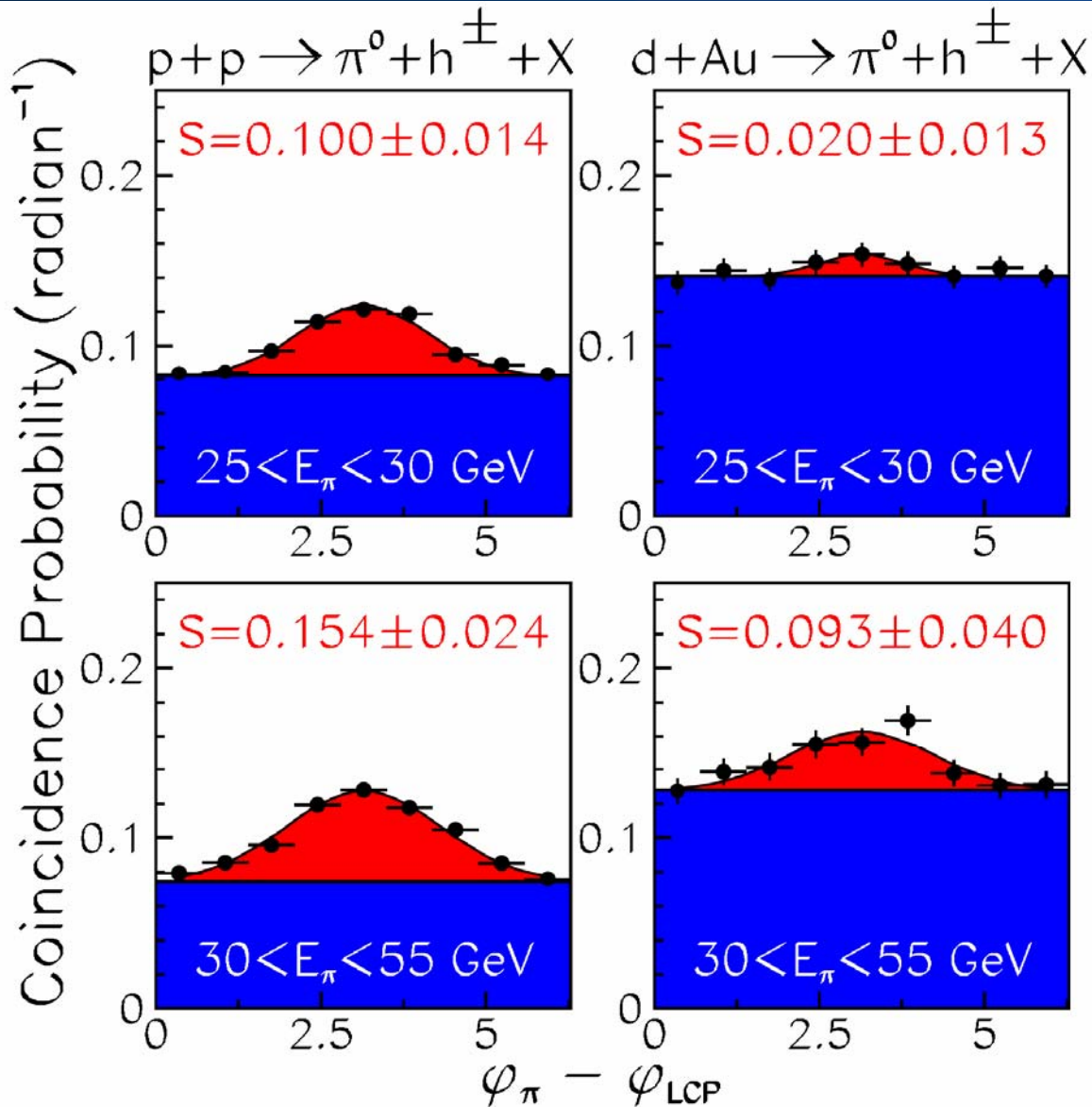

$\varphi_\pi$  of forward pion is correlated with leading ( $p_T > 0.5 \text{ GeV}/c$ )  $h^\pm$  at mid-rapidity.

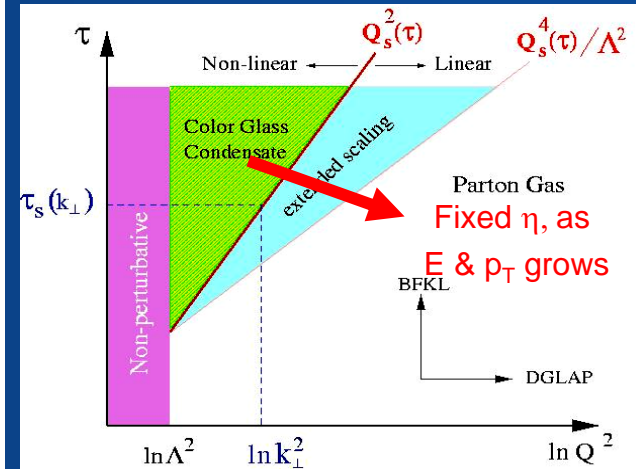

Azimuthal correlations are suppressed at small  $\langle x_F \rangle$  and  $\langle p_{T,\pi} \rangle$   
**Qualitatively** consistent with CGC picture

# PHENIX Azimuthal Angle correlations

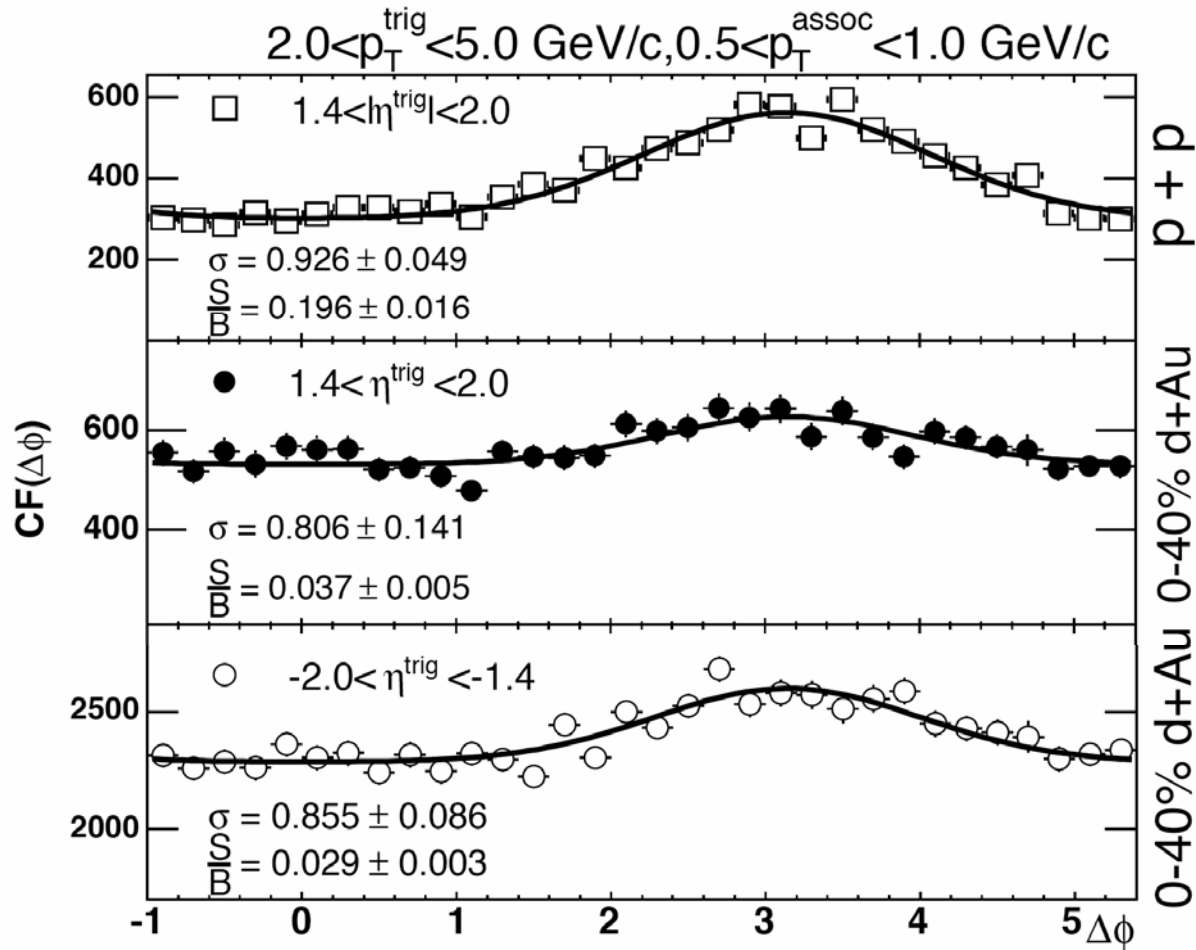

**Azimuthal angle correlation between charged hadrons.**

**Trigger :**

$1.4 < \eta < 2$  d muon-arm -  
 $1.4 > \eta > -2$  Au muon-arm

**Associated particle:**

$|\eta| < 0.35$   $0.5 < p_T < 1 \text{ GeV}/c$

$$CF = \frac{dN(\Delta\phi)/d(\Delta\phi)}{acc(\Delta\phi)}$$

**Two-part. Acceptance from event mixing**

The strength of the correlation is displayed with the conditional yield  $CY = N_{\text{pair}}/\epsilon_{\text{assoc}}/N_{\text{trig}}$

$N_{\text{pair}}$  counts the events in the gaussian peak and  $\epsilon_{\text{assoc}}$  is obtained from Monte-Carlo simulations of PHENIX

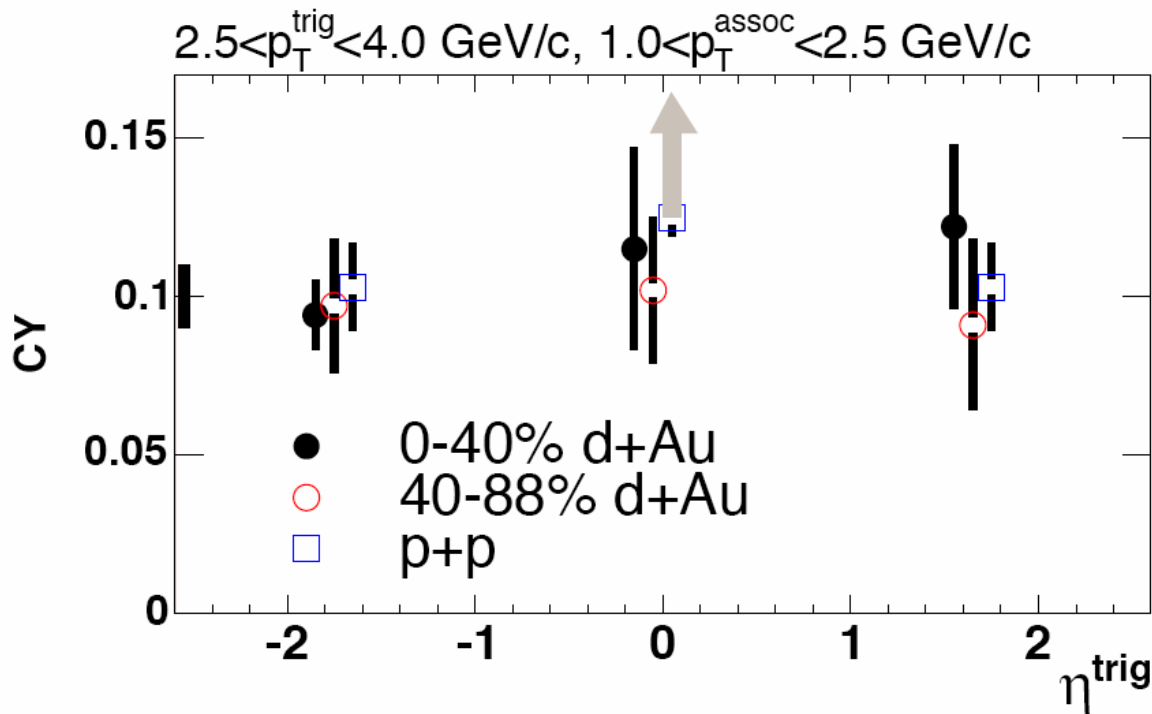

All points are consistent with no rapidity effect.

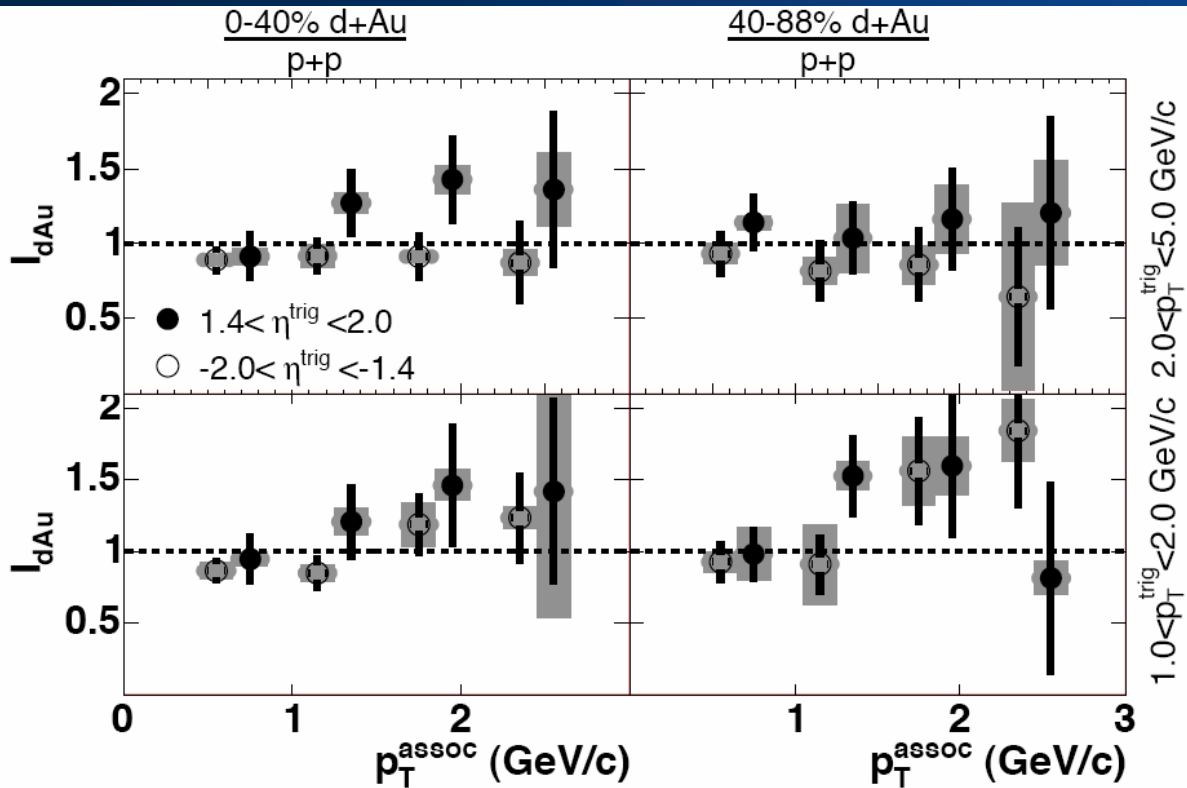

**This ratio is expected to drop below 1 in the presence of mono-jets.**

**These ratios are consistent with one. With the exception of the central forward trigger.**

$$I_{dAu} = \frac{CY|_{d+Au}}{CY|_{p+p}}$$



# **PHENIX and STAR upgrades related to Forward physics**

**Both Big experiments PHENIX and STAR have embarked in large projects to improve their high rapidity coverage.**

**Some of these projects start to be operational next year but their construction extends for several years into RHIC II**



# STAR Forward Meson Spectrometer upgrade

684 × 3.8-cm cells, 756 × 5.8-cm cells  
Include module boundary

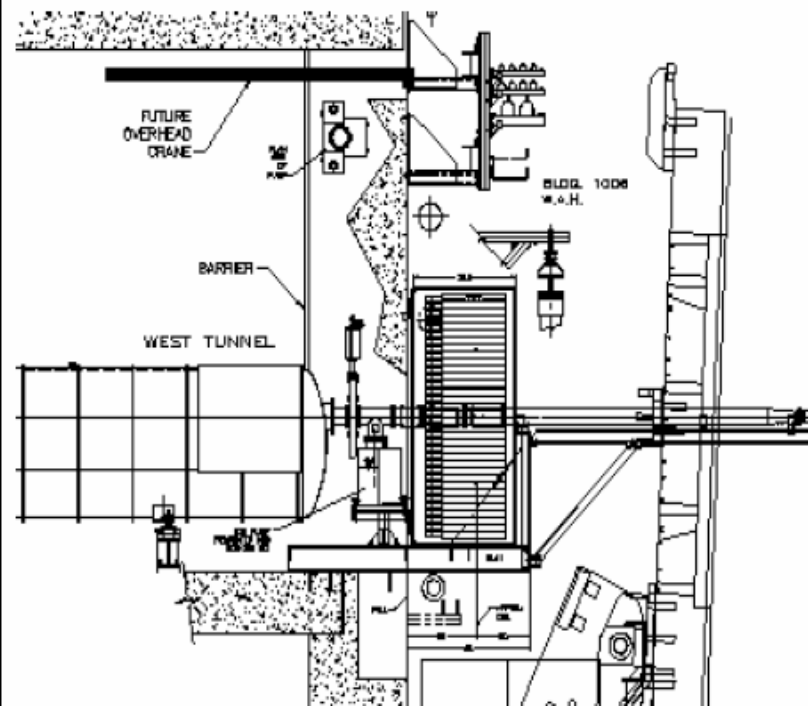
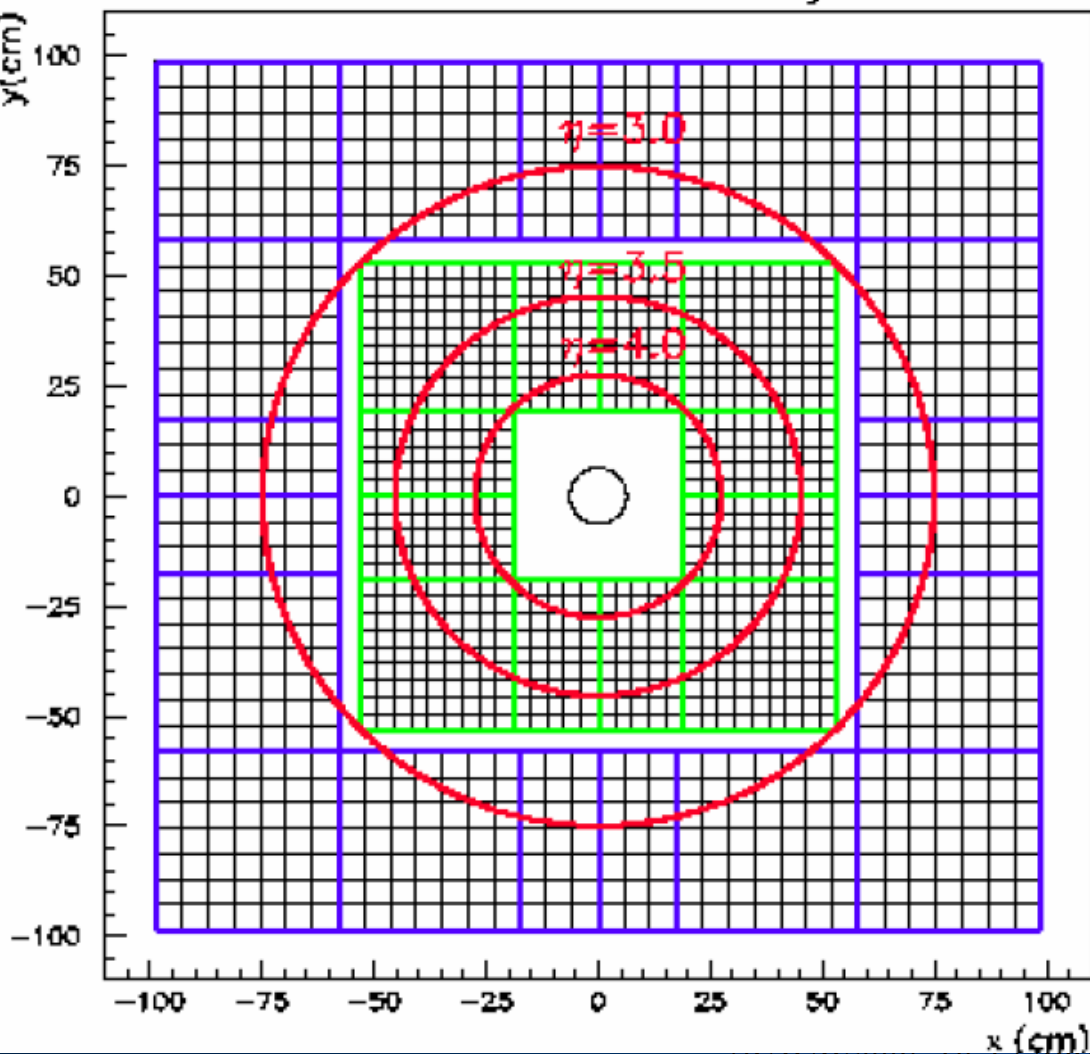

- FMS increases areal coverage of forward EMC from 0.2 m<sup>2</sup> to 4 m<sup>2</sup>
- Addition of FMS to STAR provides nearly continuous EMC from  $-1 < \eta < +4$



# $p+p$ and $d+Au \rightarrow \pi^0+\pi^0+X$ correlations with forward $\pi^0$

$p+p$  in PYTHIA

$$\eta_1 + \eta_2 = \ln(x_1/x_2)$$

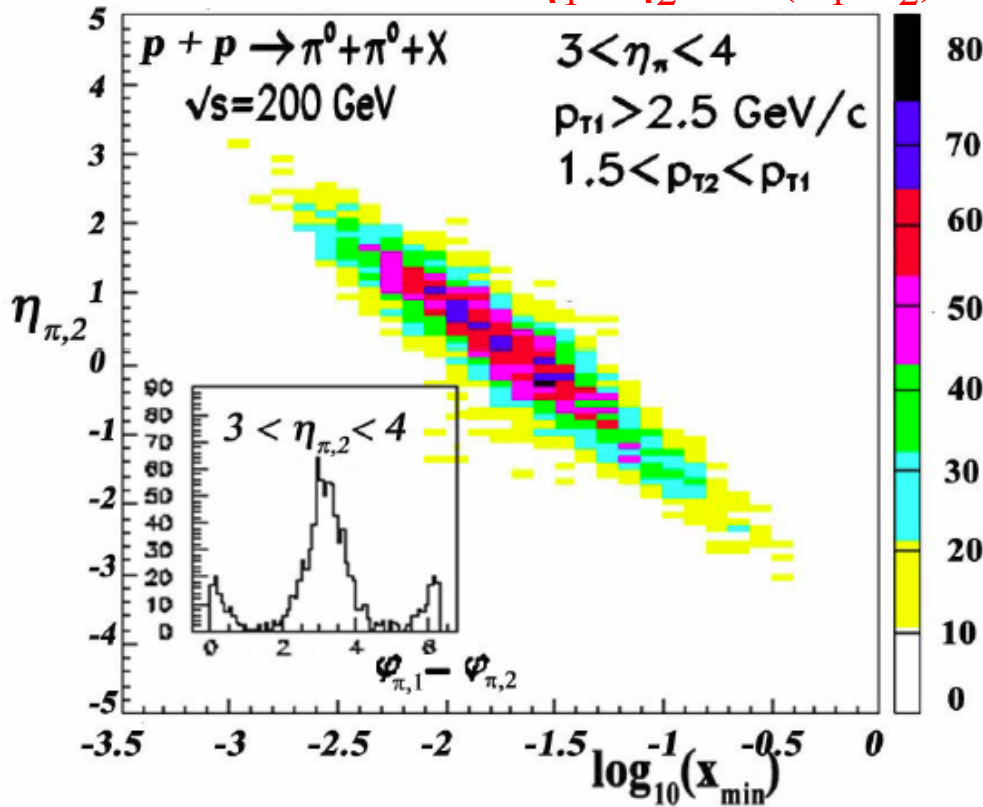

$d+Au$  in HIJING

hep-ex/0502040

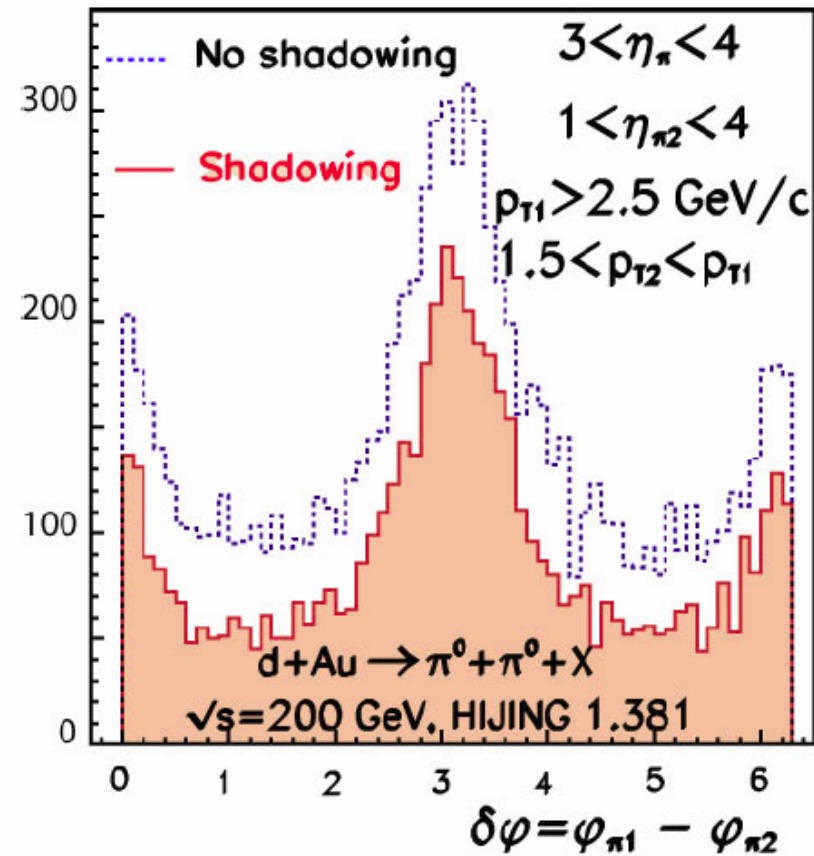

Conventional shadowing will **change yield**, but not **coincidence structure**.

Coherent effects such as CGC evolution will **change the structure**.

Sensitive to  $x_g \sim 10^{-3}$  in pQCD scenario; **few  $\times 10^{-4}$**  in CGC scenario.



# Future STAR physics prospects

## STAR tracking upgrade: conceptual layout



Forward triple-GEM Tracker (FGT)

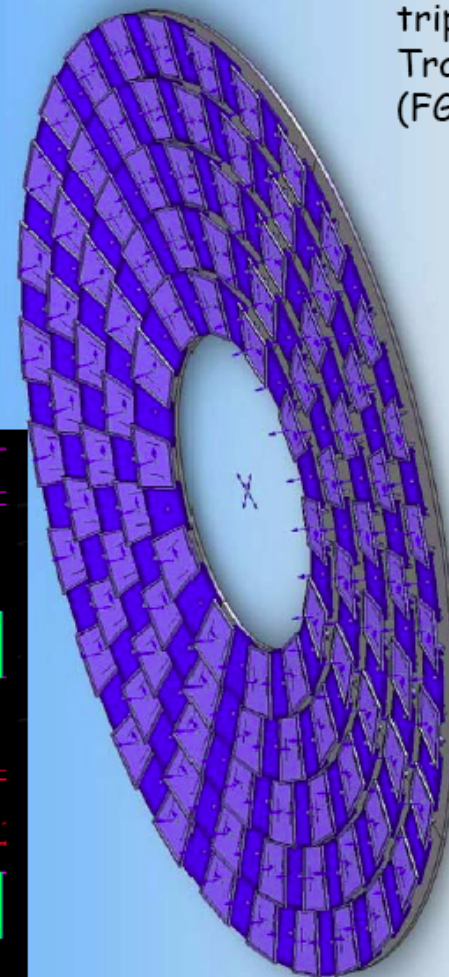

Forward Silicon Tracker (FST)

APS pixel detector - Heavy Flavor Tracker (HFT)

Inner Silicon Tracker (IST)

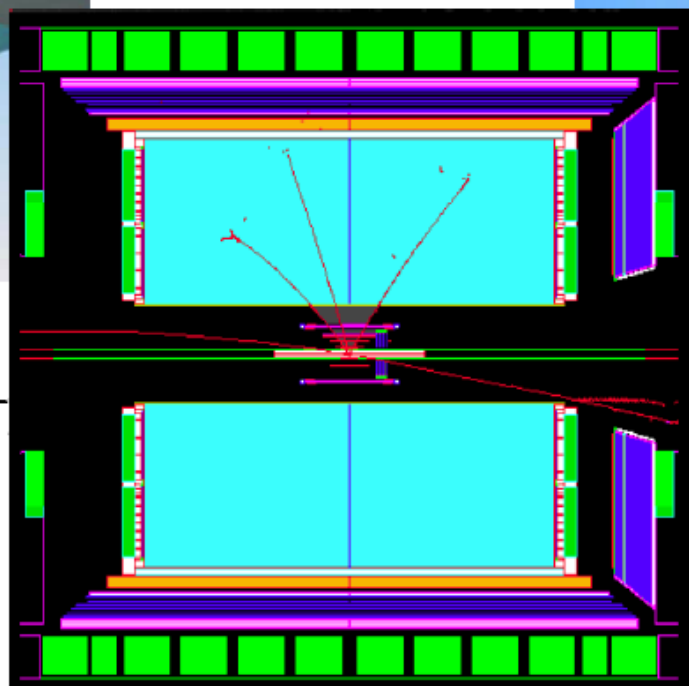



# PHENIX Silicon Vertex Tracker

- PHENIX: Si-VTX collaboration
  - 72 collaborators from 14 institutions
  - BNL, Florida State Univ., Iowa State Univ., KEK, Kyoto Univ., LANL, Niigata Univ., ORNL, RIKEN, RIKEN BNL Reas. Center, Stony Brook Univ., Univ. New Mexico, LLR
- ~\$3M funds to date (RIKEN)

- PHENIX: F-VTX
  - Proposal in preparation
  - LANL LDRD approval to construct  $\frac{1}{4}$  of  $2\pi$  prototype
  - Developing connection with FNAL Si-Det lab

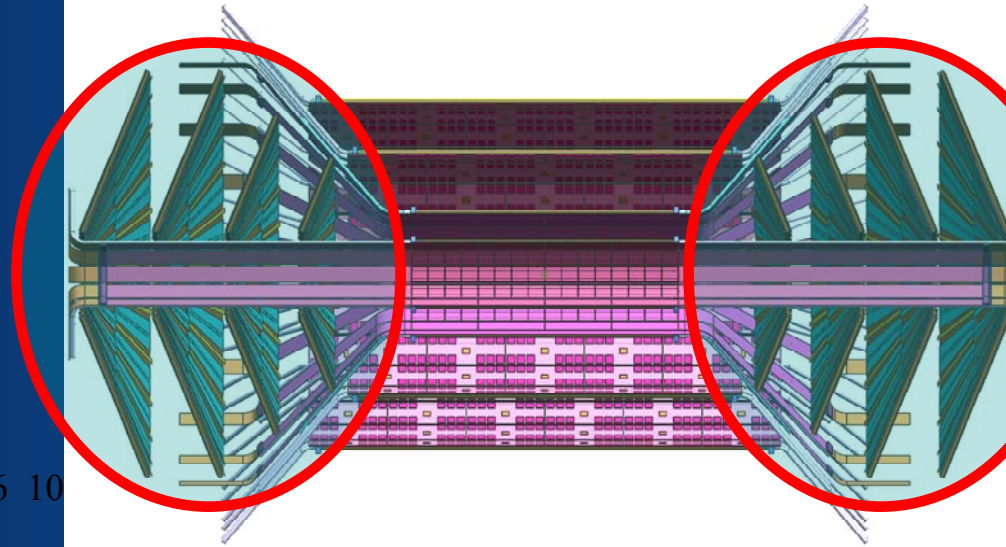

# PHENIX Nose-Cone Calorimeter

- Replace existing PHENIX “nose-cones” (hadronic absorbers for muon arms) with Si-W calorimeter
- Major increase in acceptance for photon+jet studies, will extend  $|\eta|$  to 3.
- Prototype silicon wafer with
  - 3 different versions of “strip-pixel” detectors for the pre-shower and shower max layers

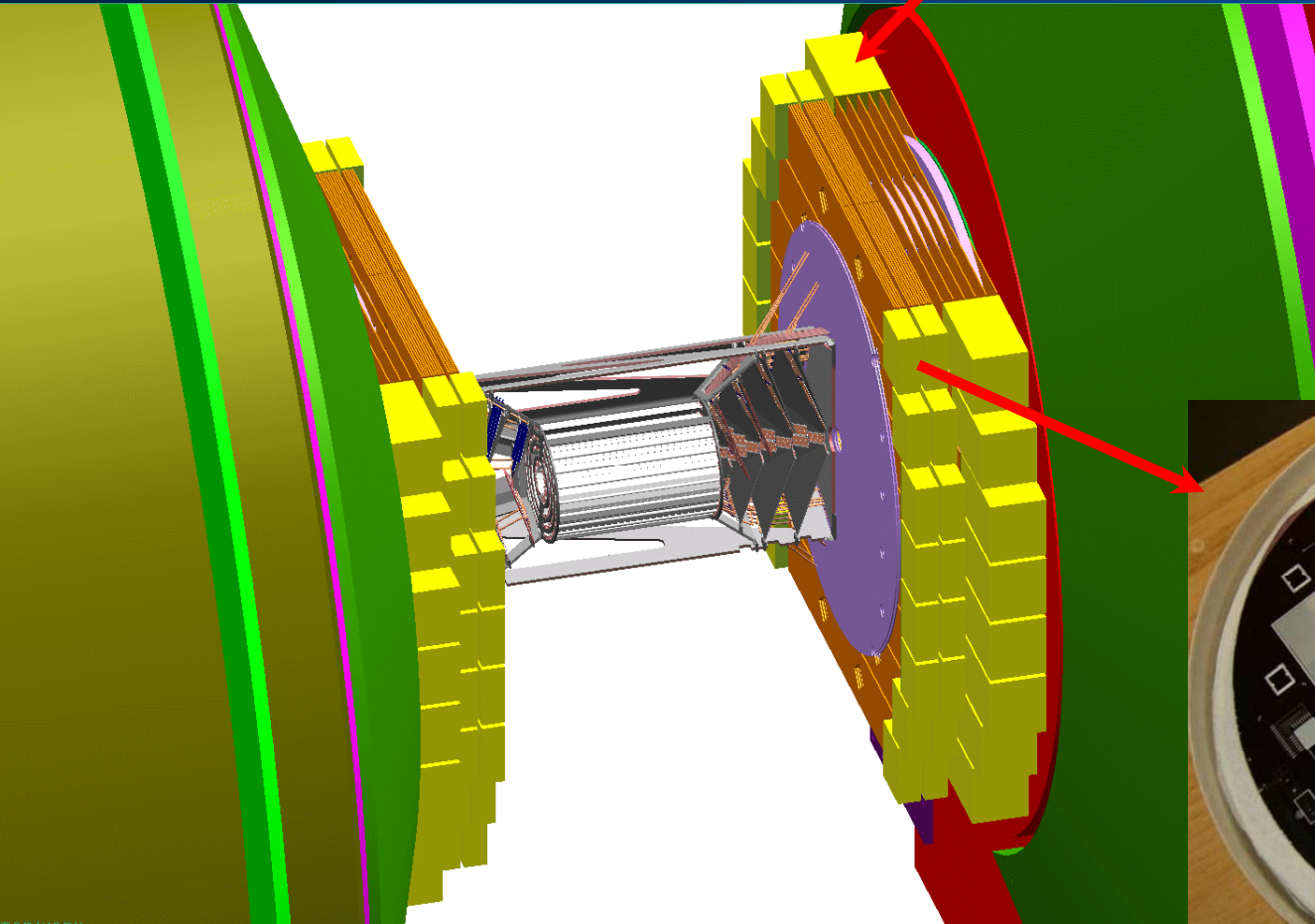

$\pi^0 \rightarrow \gamma\gamma$ ,  $d = 25$  mm

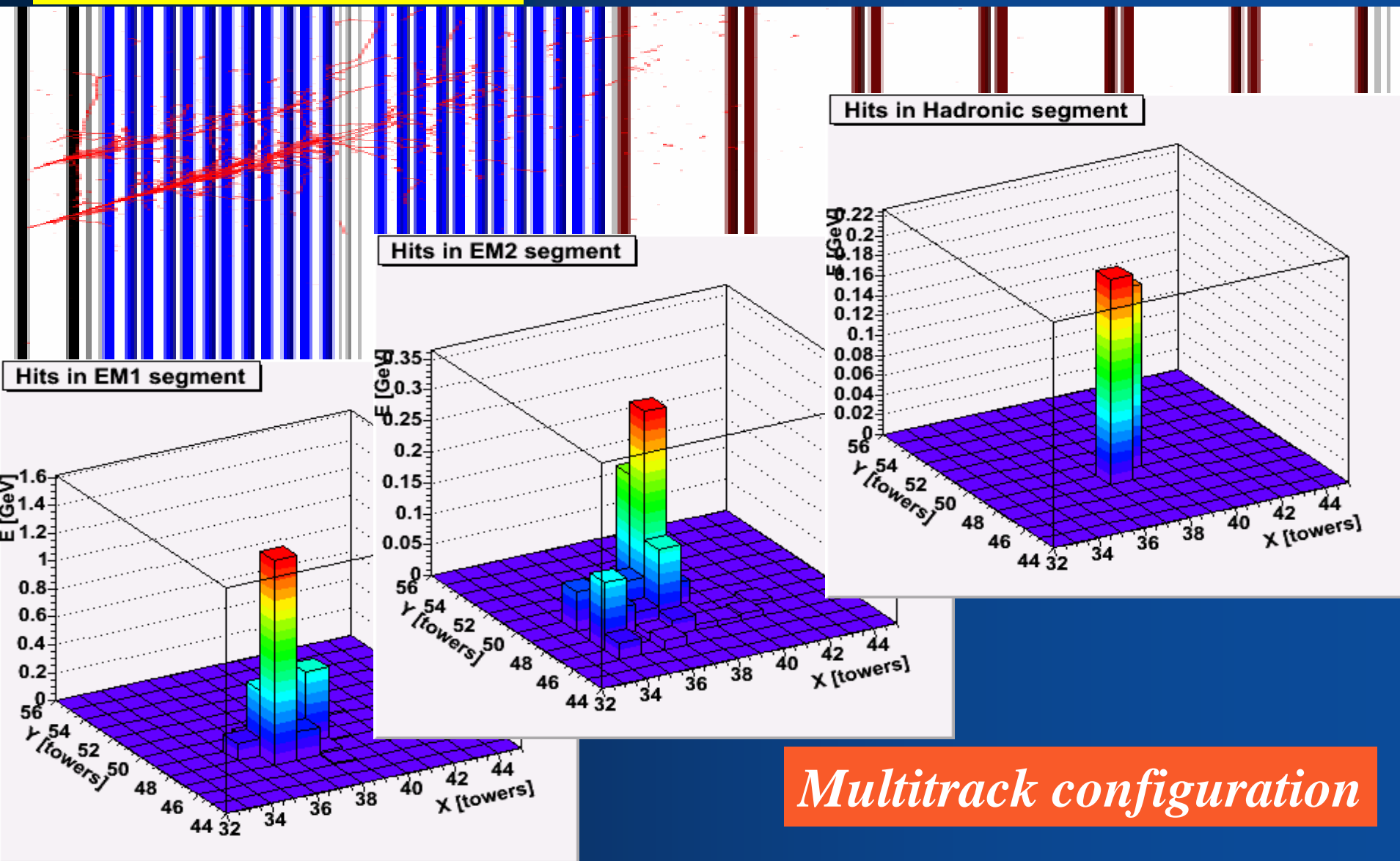

*Multitrack configuration*

Pi0 Hits in X-strips (PreShower)

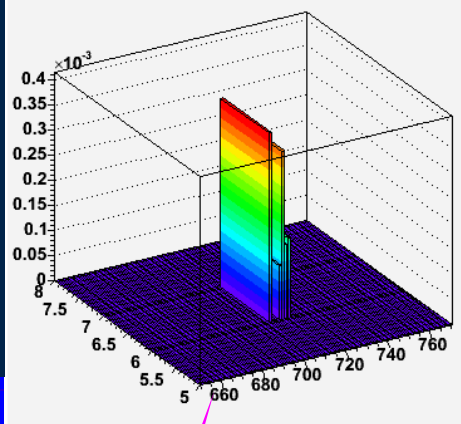

Pi0 Hits in X-strips (ShowerMax)

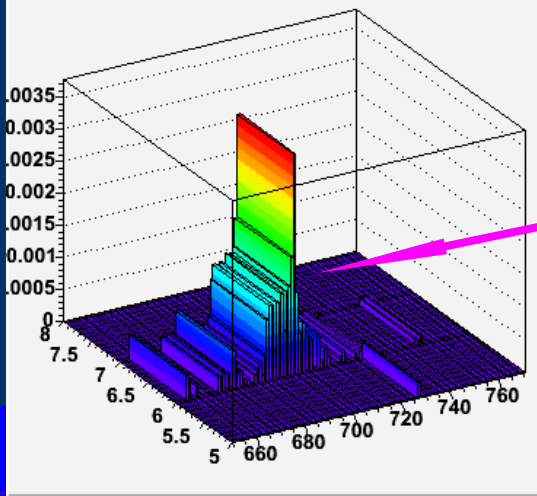

*ShowerMax*

Pi0 Hits in Y-strips (PreShower)

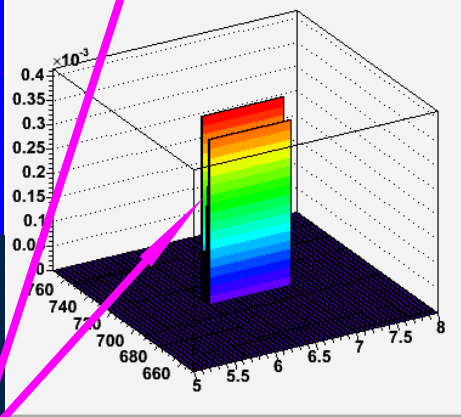

Pi0 Hits in Y-strips (ShowerMax)

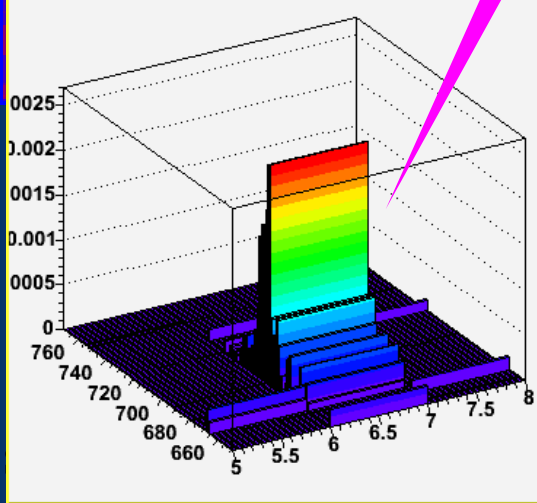

*PreShower*

$\Delta(\gamma\gamma) \sim 4 \text{ mm}$   
 $\pi^0 \ 30 \text{ GeV}/c$



# Expected $\pi^0$ reconstruction efficiency

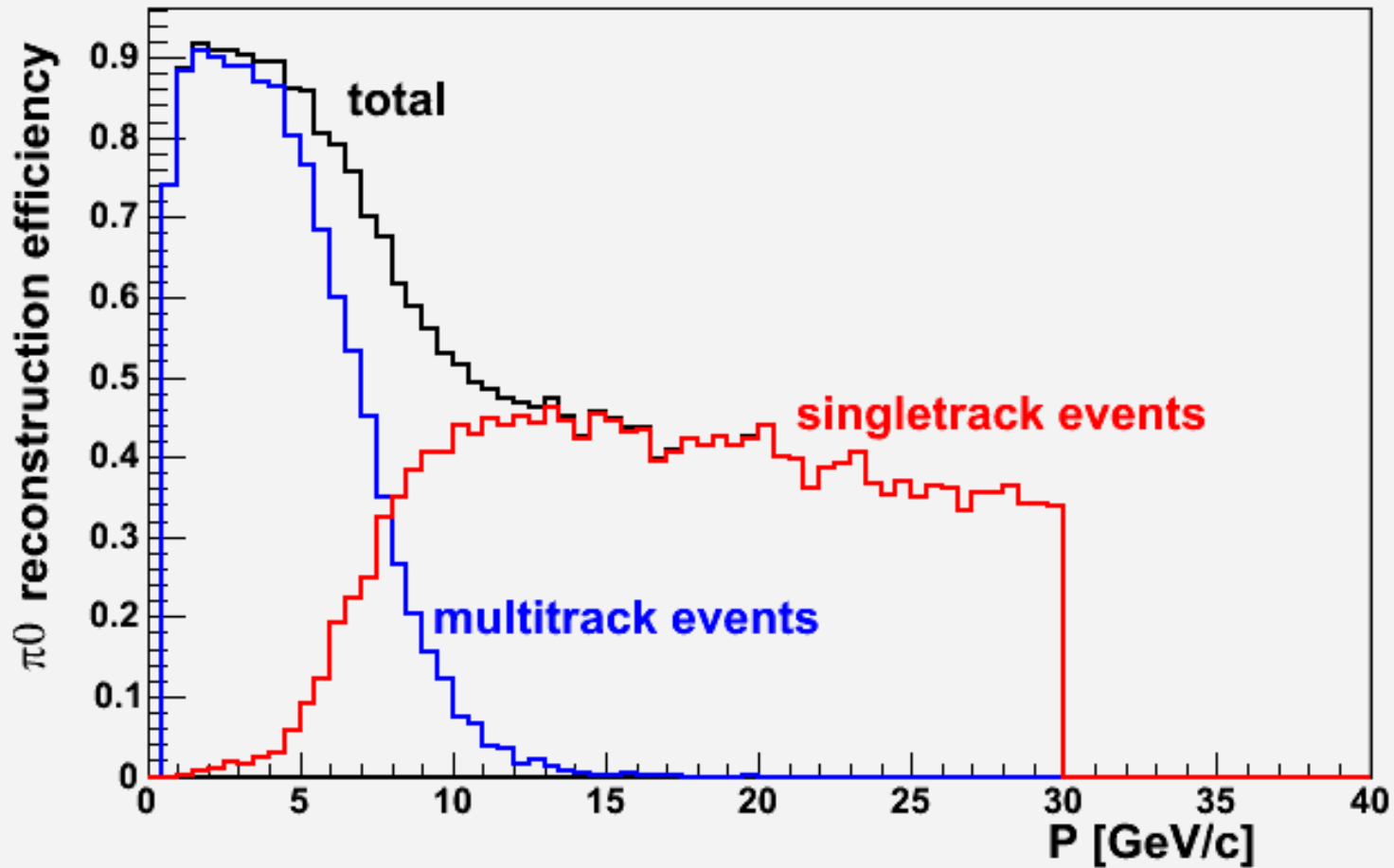

# Summary and outlook

Very interesting results at high rapidity have been obtained in d+Au collisions by all the RHIC experiments.

These results may be related to the onset of saturation in the wave function of the Au target and the formation of a Color Glass Condensate.

Other explanations of that data have been advanced with similar success.

The big experiments PHENIX and STAR have embarked in detector upgrades that will increase the forward coverage and provide probes that go beyond the inclusive particle productions studied so far.

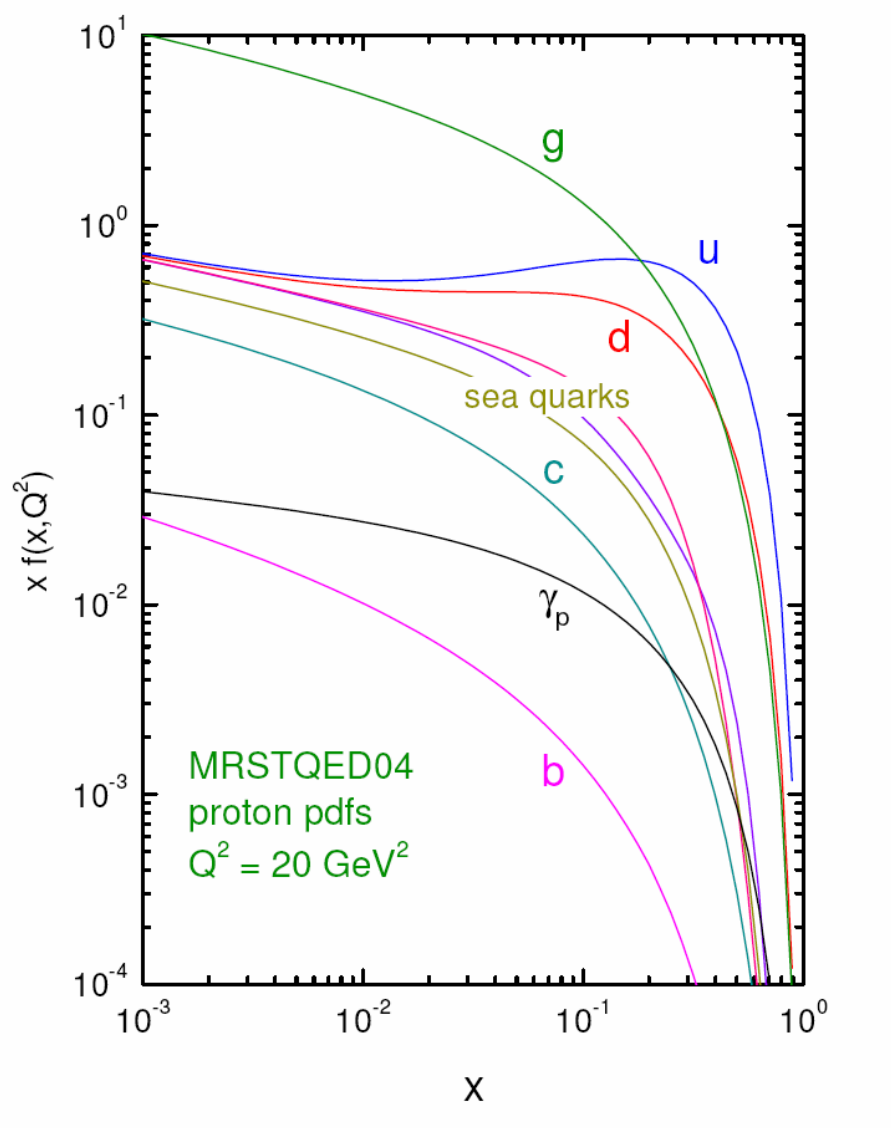

# PHENIX $J/\psi$ measurements in d+Au collisions

$J/\psi$  measurements with the muon arms and with di-electrons at mid-rapidity open a wide window into the Au wave function:

- Gluon (anti-)shadowing
- Nuclear absorption.
- Initial state energy loss.
- Cronin effect

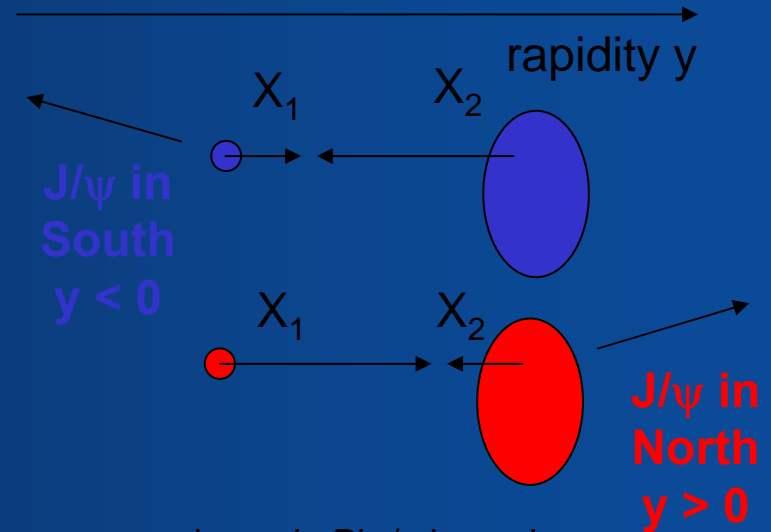

South ( $y < -1.2$ ):

- large  $X_2$  (in gold)  $\sim 0.090$

Central ( $y \sim 0$ ):

- intermediate  $X_2 \sim 0.020$

North ( $y > 1.2$ ):

- small  $X_2$  (in gold)  $\sim 0.003$

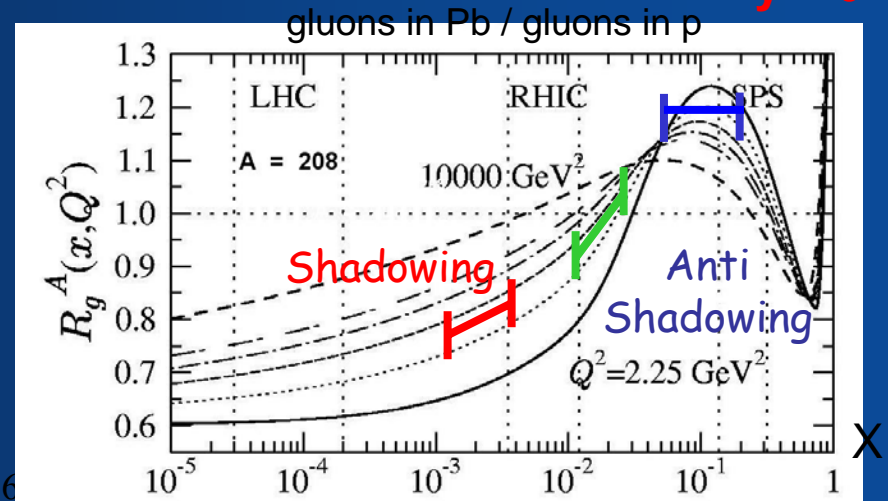

# Similar rapidity and centrality behavior as charged particles,

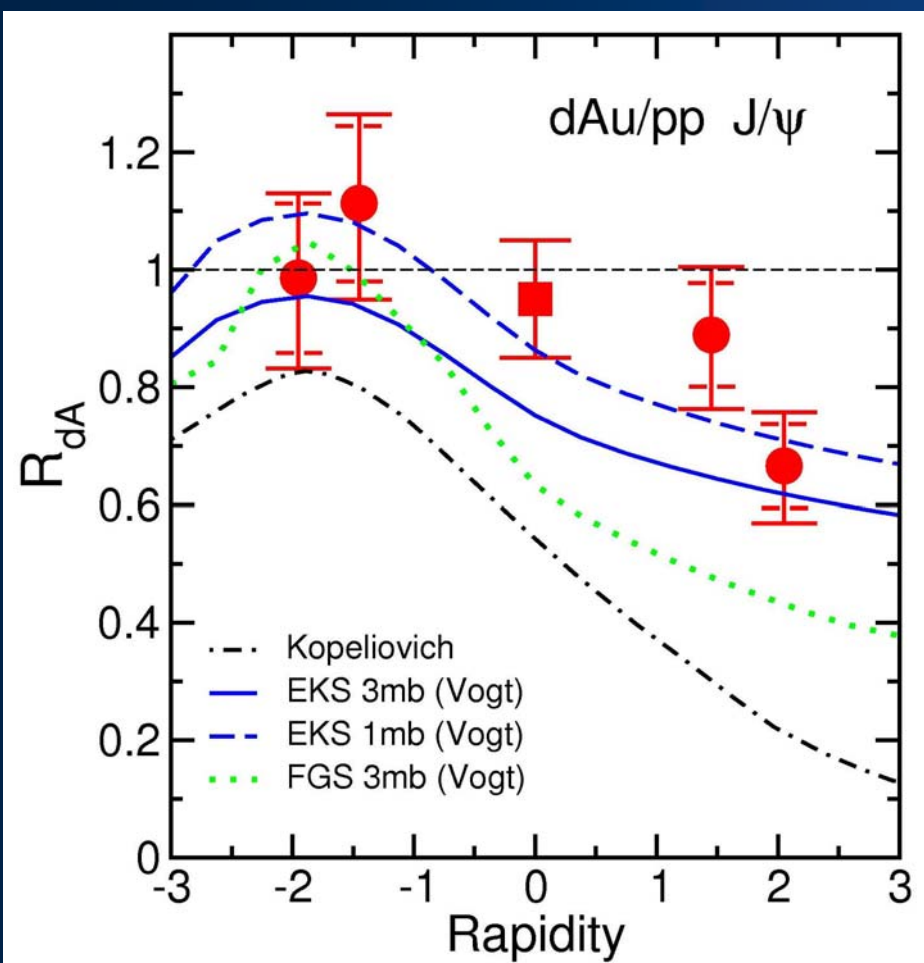

$$R_{dA} = \frac{Yield_{inv}^{dA}}{\langle N_{coll} \rangle Yield_{inv}^{pp}}$$

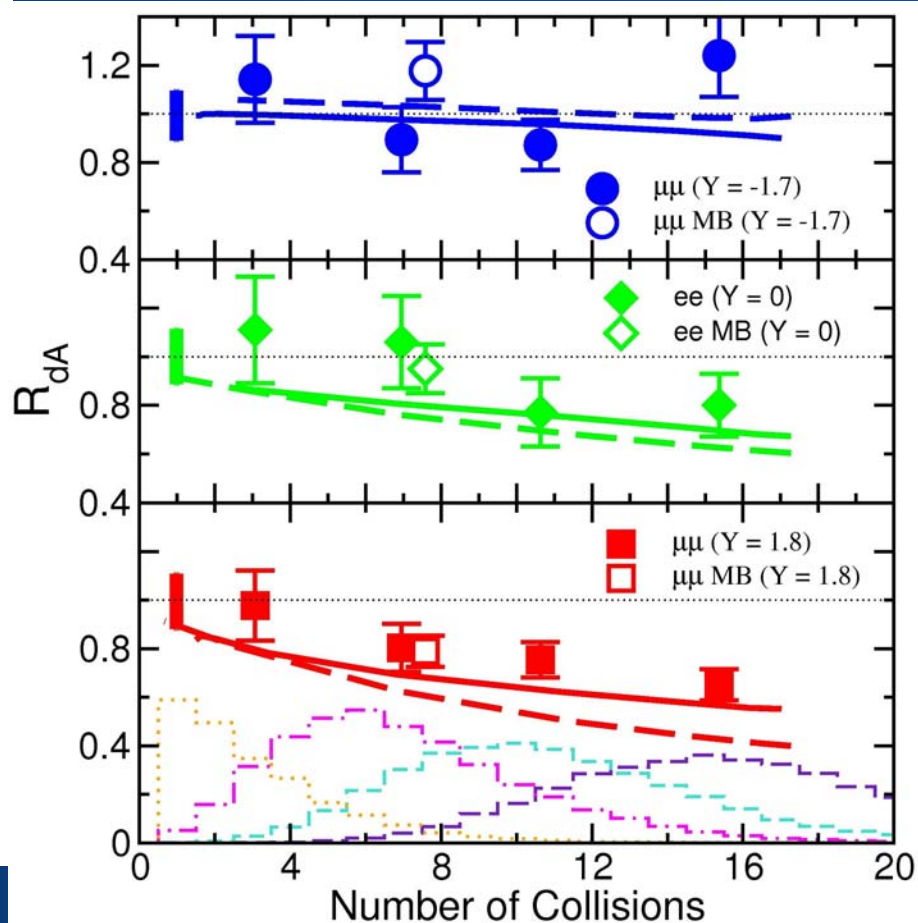

But this time the data is better described by modest shadowing

# PHENIX Upgrade Physics

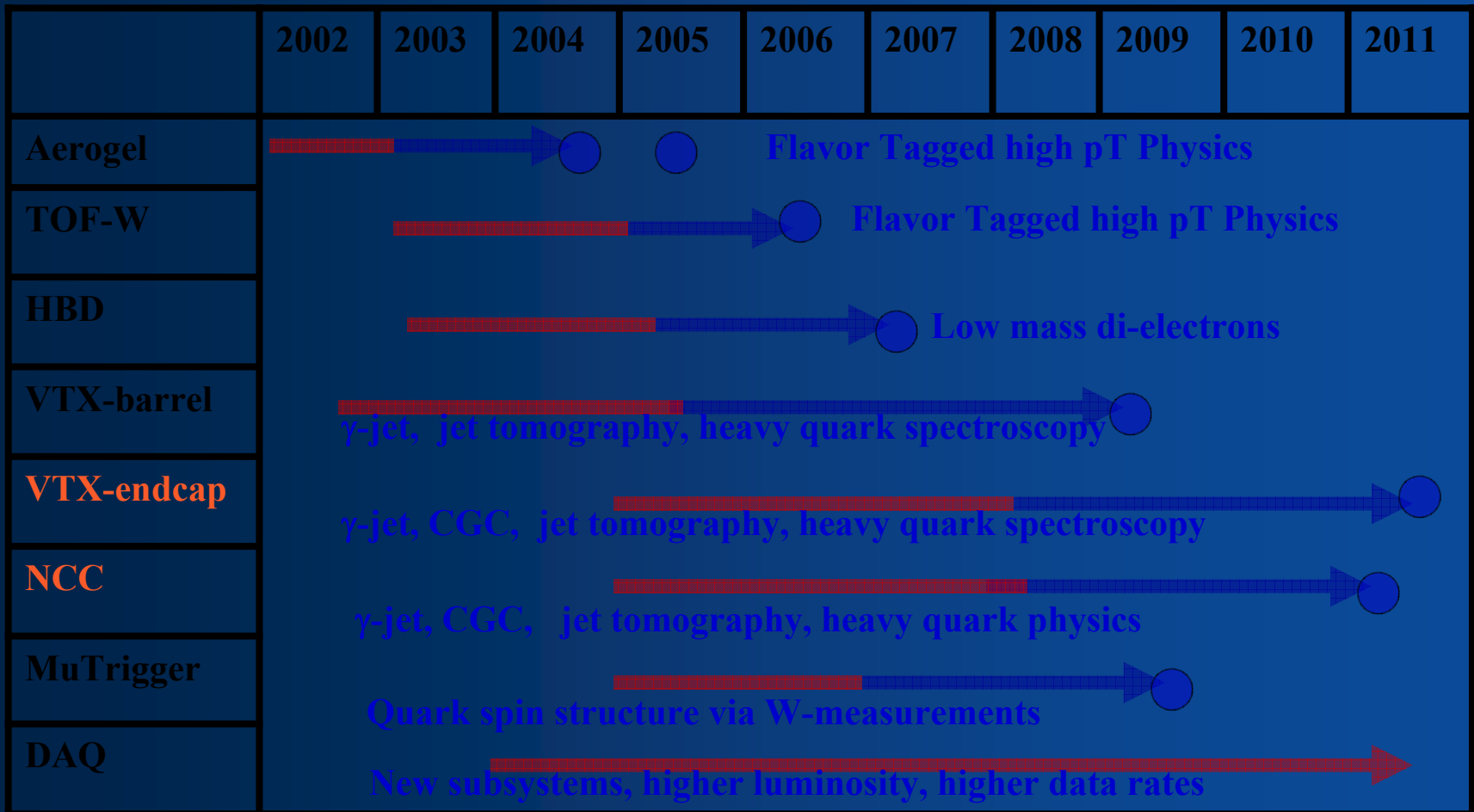

█ R&D Phase     
 █ Construction Phase     
 ● Ready for Data